

# PULSE ROBOTIC ARM

## USER MANUAL



**Contact information:**

Rozum Robotics LLC  
4/5 Biryuzova St., Suite 151  
220073, Minsk, Belarus  
Tel.: +375 33 376 04 60



---

**TABLE OF CONTENTS**

<b>INTRODUCTION</b> .....	5
<b>WARNING SIGNS AND THEIR MEANINGS</b> .....	5
<b>1 ABOUT THE PULSE SERIES</b> .....	6
<b>1.1 Use restrictions</b> .....	6
<b>1.2 Supply package</b> .....	7
<b>1.3 Operating conditions</b> .....	7
<b>1.4 Robotic arm</b> .....	7
1.4.1 Specifications.....	9
1.4.2 Dimensions.....	10
1.4.3 Motion range and workspace restrictions.....	10
<b>1.5 Control box</b> .....	12
1.5.1 The front panel.....	12
1.5.2 The back panel.....	13
1.5.3 Sound signals.....	13
<b>1.6 Emergency stop button</b> .....	14
<b>1.7 Wrist</b> .....	15
<b>1.8 Electrical connections of PULSE arms</b> .....	16
1.8.1 Power connection.....	16
1.8.2 Digital I/O connectors.....	16
<b>1.9 States and modes of PULSE arms</b> .....	18
1.9.1 Normal states and modes.....	18
1.9.2 Emergency state.....	19
1.9.3 Untwisting mode.....	20
<b>1.10 Safe operation requirements</b> .....	22
<b>2 INTEGRATING INTO AN APPLICATION</b> .....	23
<b>2.1 Preparatory works</b> .....	23
<b>2.2 Mounting an arm</b> .....	23
<b>2.3 Installing a control box</b> .....	24
<b>2.4 Connecting the arm components, the network, and external devices</b> .....	25
<b>2.5 Mounting an end effector</b> .....	27
<b>2.6 Pre-commissioning checks</b> .....	29
<b>3 GETTING STARTED WITH THE ROBOTIC ARM</b> .....	29

---

<b>3.1</b>	<b>Switching the arm</b> .....	29
<b>3.2</b>	<b>Setting communication with the PULSE arm</b> .....	30
3.2.1	Static IP.....	30
	Windows OS .....	31
	Linux OS .....	34
3.2.2	Dynamic IP .....	36
<b>4</b>	<b>THE PULSE DESK USER INTERFACE</b> .....	38
<b>4.1</b>	<b>Accessing the PULSE DESK software</b> .....	38
<b>4.2</b>	<b>Edit screen</b> .....	39
<b>4.3</b>	<b>The Main Menu of PULSE DESK</b> .....	41
<b>5</b>	<b>PROGRAMMING WITH PULSE DESK</b> .....	42
<b>5.1</b>	<b>Completing the Edit stage</b> .....	42
5.1.1	Creating a program .....	42
5.1.2	Adding commands to a program body.....	43
5.1.3	Adding a comment to a program .....	46
5.1.4	Setting command parameters .....	46
5.1.4.1	Wait for command.....	47
5.1.4.2	Send to command.....	48
5.1.4.3	Delay command .....	49
5.1.4.4	Point command .....	50
5.1.5	Deleting commands .....	52
5.1.6	Relocating commands.....	52
5.1.7	Renaming commands.....	52
<b>5.2</b>	<b>Debugging a program</b> .....	53
5.2.1	The Check stage screen .....	53
5.2.2	Conducting a test run .....	54
<b>5.3</b>	<b>Running a program</b> .....	55
5.3.1	Program execution.....	56
5.3.2	Stopping a program .....	56
5.3.2.1	Emergency stop .....	56
5.3.3	Saving a program.....	57
5.3.4	Renaming a program.....	57
<b>5.4</b>	<b>Managing programs</b> .....	58
5.4.1	Loading a program.....	58

---

5.4.2	Deleting a program .....	58
<b>5.5</b>	<b>Closing PULSE DESK.....</b>	<b>58</b>
<b>5.6</b>	<b>Updating PULSE DESK.....</b>	<b>59</b>
5.6.1	Direct updating via Internet.....	59
5.6.2	Updating from a USB.....	60
<b>6</b>	<b>CONTROLLING THE ARM VIA REST API.....</b>	<b>61</b>
<b>7</b>	<b>SANDBOX.....</b>	<b>63</b>
	Operating the sandbox .....	63
	Loading external software to the sandbox .....	63
<b>8</b>	<b>SWITCHIN OFF THE PULSE ARM.....</b>	<b>64</b>
<b>ANNEX I. SAMPLE PULSE DESK PROGRAM.....</b>		<b>65</b>
	Starting PULSE DESK .....	65
	Creating a new program.....	66
	Setting a basic trajectory by hand guiding .....	67
	Setting intermediary waypoints .....	71
	Verifying and editing the trajectory .....	73
	Adding a comment and setting other commands.....	73
	Conducting a test run .....	76
	Executing and stopping the program .....	78
<b>ANNEX II. KINEMATICS OF THE PULSE ARM.....</b>		<b>79</b>
<b>ANNEX III. TROUBLESHOOTING .....</b>		<b>81</b>

## INTRODUCTION

The instructions and recommendations in this manual are intended to assist integrators and operators of the PULSE-series robotic arms in the following:

- understanding the operating principles of their hardware and software components
- installing the arm components, as well as integrating the arm into user applications
- commissioning the robotic arm
- using the PULSE DESK interface and other software means to program and control the arm

## WARNING SIGNS AND THEIR MEANINGS

Below are the warning symbols used throughout the manual and their meanings.



*The sign denotes important information that is not directly related to safety, but that the user should be aware of.*



*The sign indicates important safety precautions the user should follow.*

# 1 ABOUT THE PULSE SERIES

The PULSE series comprises two models of robotic arms—PULSE 75 and PULSE 90. Each model is a lightweight manipulator intended for collaborative operation in industrial and commercial applications.



***PULSE series arms are designed to operate safely in close proximity to humans. However, the integrator should conduct a risk assessment for each particular installation to evaluate the need for additional safety devices (e.g., safeguards).***



Figure 1-1: PULSE 75 and PULSE 90

Apart from the arm proper, each PULSE-series robot includes the hardware and software components listed in **Table 1-1**.

**Table 1-1: Hardware and software components supplied with the PULSE robotic arm**

Component	Intended use
<b>Hardware</b>	
Control box	To control operation of the PULSE robotic arm
Emergency stop button	To ensure Category 1 stop of the robotic arm in an emergency
<b>Software</b>	
PULSE DESK	To program the PULSE robotic arm to move along a desired trajectory and perform different kinds of operations with a work tool

## 1.1 Use restrictions

Make sure to observe the following use restrictions applicable to PULSE robotic arms:



**Failure to observe the restrictions shall constitute a misuse, making our warranty void.**

- Never install or operate PULSE robotic arms in an explosive or flammable environment.
- The atmosphere at the operating location of a robotic arm should not contain corrosive gases or liquids, salt, radioactive substances, oil mist, dust or metal powders.
- Always conduct a risk assessment of the operating environment before installing and operating a PULSE robotic arm.
- Avoid using PULSE robotic arms outside the operating conditions (see **Section 1.3**).

## 1.2 Supply package

The supply package of a PULSE robotic arm contains:

- a robotic arm assembled with a transition plate and a wrist
- a control box
- an emergency stop button pre-assembled with a connection cable
- a 220 V power cable
- a hybrid cable to connect the robotic arm and the control box

## 1.3 Operating conditions

PULSE robotic arms is intended **for indoor use only**. When operating it, make sure to comply with the following requirements:

- Ambient temperature: 0°C to +35°C
- Humidity: 80%
- Altitude: max. 1,000 m above the sea

## 1.4 Robotic arm

A PULSE robotic arm has modular design comprising structural elements as below (**Figure 1-2**):

- aluminum alloy tubes **(1)**
- Rozum Robotics self-designed servo motors **(2)**
- elbow fittings **(3)**



**Figure 1-2: Structural elements of the PULSE robotic arm**

The structural elements form six interlinked axes (see **Figure 1-3**). In addition to the elements, the arm includes the following:

- an end effector mounting flange (a wrist)
- an arm base
- a transition plate

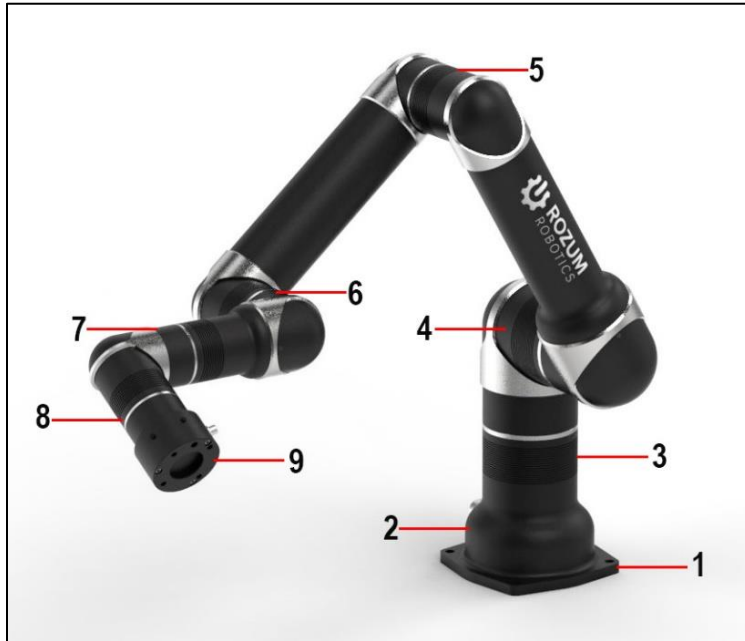

1	Transition plate
2	Arm base
3	Axis 1
4	Axis 2
5	Axis 3
6	Axis 4
7	Axis 5
8	Axis 6
9	Wrist (end effector mounting flange)

**Figure 1-3: Design of the PULSE robotic arm**

On the elbow fitting above the wrist, there are **four control buttons** as shown below. The functions of the buttons are as described in **Table 1-2**.

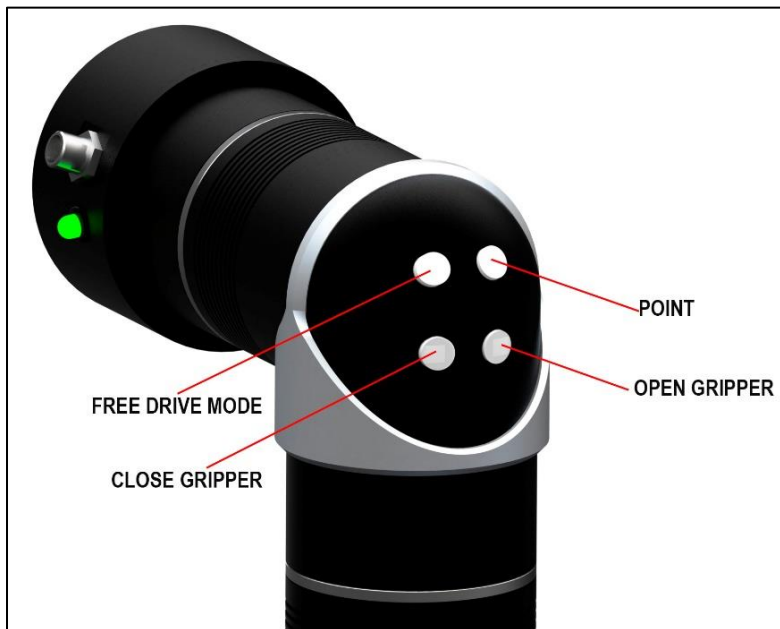

**Figure 1-4: Control buttons on a PULSE robotic arm**



**Table 1-2: Functions of the wrist buttons**

Name	Function
Free Drive mode	To enable/ disable Free Drive mode (in the mode, the user can teach an arm different trajectories by moving its axes by hand)
Point	To add points to a program running in the PULSE DESK software
Open gripper	To open the gripper attached to the wrist
Close gripper	To close the gripper attached to the wrist

### 1.4.1 Specifications

PULSE robotic arms have specifications as listed in **Table 1-3**.

**Table 1-3: Specifications of PULSE robotic arms**

Specification	PULSE 75	PULSE 90
Weight <sup>1)</sup>	12.6 kg	13.6 kg
Payload <sup>1)</sup>	6 kg	4 kg
Degrees of freedom <sup>1)</sup>	6	6
Reach <sup>1)</sup>	750 mm	900 mm
Repeatability	+/-0.1 mm	+/-0.1 mm
Non-stop lifetime cycle	20,000+ hours	20,000+ hours
Protection class	IP40	IP40
Noise level	less than 60 dB	less than 60 dB
Rated voltage	100 VAC	100 VAC
Average power	150 W	250 W
Maximum power	300 W	450 W
Maximum joint speed	30 RPM	30 RPM
Joint acceleration	5 rad/s <sup>2</sup>	5 rad/s <sup>2</sup>
Max tool center point (TCP) velocity	2 m/s	2 m/s
Acceleration time 0-1 m/s	0.1 s	0.1 s

<sup>1)</sup> The specifications can vary, depending on the customer precise requirements.

### 1.4.2 Dimensions

Figure 1-5 and Table 1-4 illustrate the dimensions of the arm's six axes for PULSE 75 and PULSE 90 models.

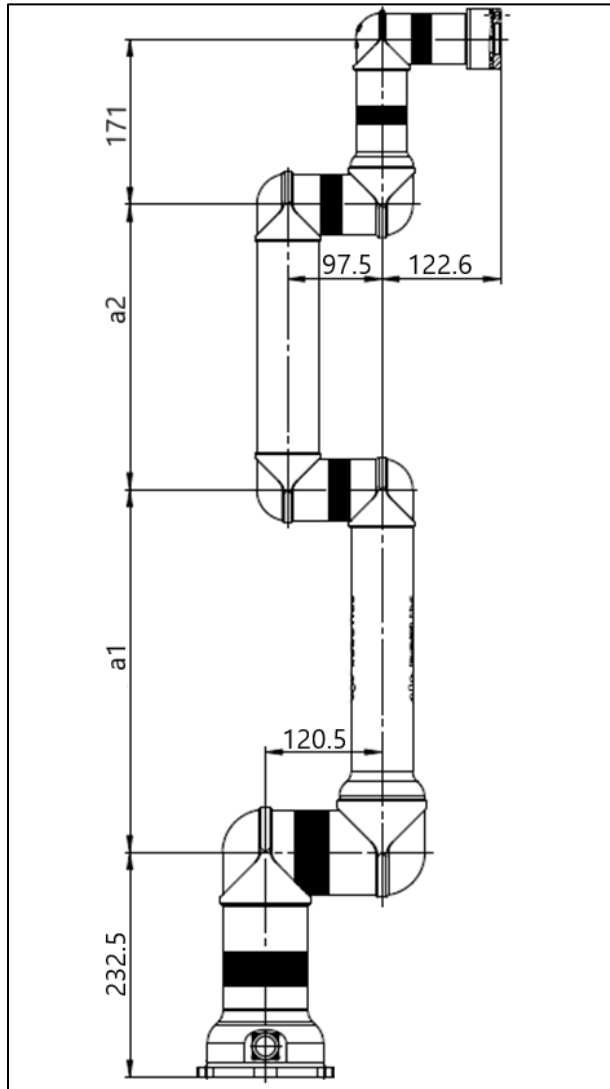

Figure 1-5: Lengths of the robotic arm axes

Table 1-4: Variations of a1 and a2 lengths for PULSE models

Model	a1, mm	a2, mm
PULSE 75	375	295
PULSE 90	450	370

### 1.4.3 Motion range and workspace restrictions

Table 1-5 contains motion ranges for each of the axes.

Table 1-5: Motion ranges and maximum speeds of the robot axes

Axis	Motion range	Maximum speed
Axis 1 (base)	-360° to 360°	180°/s
Axis 2	-360° to 360°	180°/s
Axis 3	-160° to 160°	180°/s
Axis 4	-360° to 360°	180°/s
Axis 5	-360° to 360°	180°/s
Axis 6	-360° to 360°	180°/s

Figure 1-6 illustrates the workspace of PULSE robotic arms.

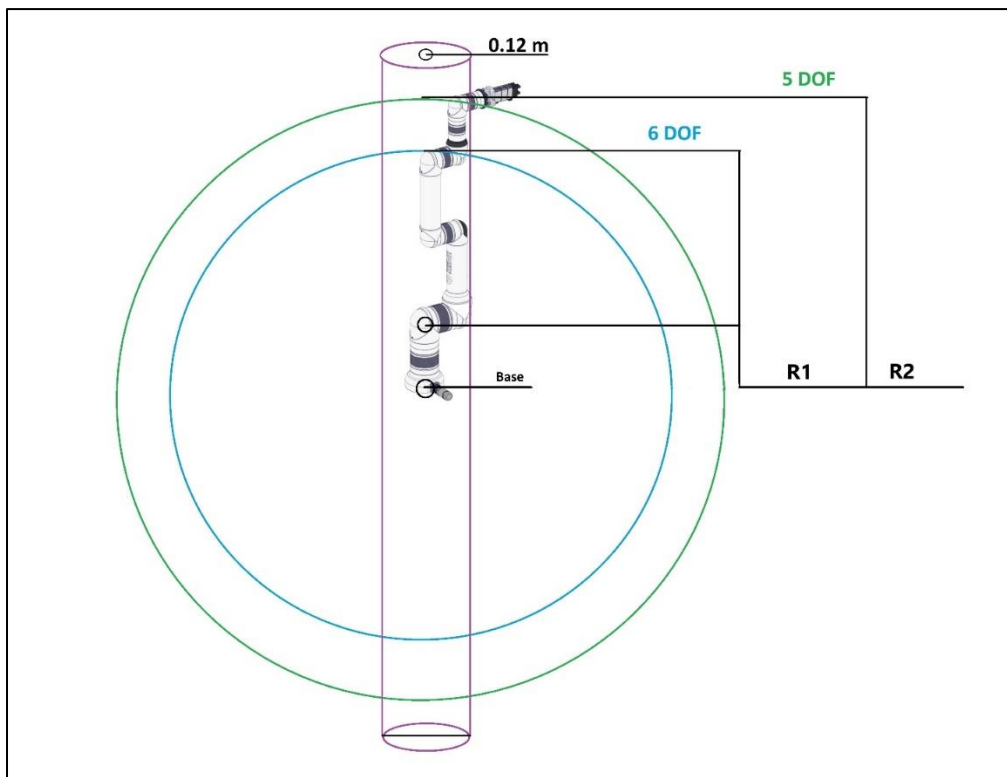

Figure 1-6: Workspace of PULSE robotic arms



**The cylinder-shape area of 0.12 m in diameter around the robot base is the infinite solutions area. It is advisable to avoid programming any arm or work tool moves within the area.**

Table 1-6 contains the R1 and R2 workspace values for PULSE 75 and PULSE 90.

Table 1-6: PULSE workspace for six and five DOF

Model	R1, m	R2, m
PULSE 75	0.67	0.83
PULSE 90	0.82	0.98

## 1.5 Control box

The control box monitors and controls PULSE arms, providing an interface for communication between hardware and software components.



***Always use an arm with a control box from the same supply package! Otherwise, the arm will not start.***

After you start a PULSE arm, the control box compares the arm identifier (ID) saved in its memory with the ID of the currently connected arm. When the two IDs match, the initialization of the arm continues in the normal way (see **Section 3.1**). When the two IDs do not match, the arm fails to initialize, which is indicated by the red LED lighting up on the front panel of the control box.

Structurally, a control box is a case of the dimensions as indicated in **Table 1-7**. It comprises a personal computer (PC) module with pre-installed control software (PULSE DESK), as well as other modules that perform communication, safety, and other essential functions.

**Table 1-7: Specifications of the control box**

Specification	Value
Weight	9 kg
Dimensions (D x W x H)	283 x 483 x 91 mm
Noise level	Less than 60 dB
Protection rating	IP21
Interfaces	<ul style="list-style-type: none"> <li>▪ 4 digital inputs, 2 digital outputs</li> <li>▪ 1 USB port</li> <li>▪ 1 Ethernet port (RJ-45, 100 BASE-T)</li> </ul>
API implementation options	<a href="#">REST API</a> / <a href="#">Python</a>

### 1.5.1 The front panel

On the front panel of the control box, there are two light-emitting diodes (LED) — a green and a red one. The front panel LEDs signal different arm states as described in **Table 1-8**.



**Figure 1-7: The front panel of the control box**

**Table 1-8: LEDs on the front panel of the control box**

Purpose	Robotic arm state	LED color	Mode
Signals states	Switched off	Green	LED off
	Bootup		blinking
	Ready		constantly ON
	Work		constantly ON
	Error		blinking
Signals errors	Switched off	Red	LED off
	Error		constantly ON

### 1.5.2 The back panel

On the back panel of the control box, you can find the following:

No.	Intended use
1	4 digital inputs and 2 digital outputs (for details, see <b>Section 1.8.2</b> )
2	USB 2.0 port
3	Ethernet port (for specifications, see <b>Table 1-7</b> )
4	Power supply switch
5	220 V power cable connector
6	Connector for an emergency stop button
7	48 V connector for the cable between the control box and the arm
8	mounting holes



**Figure 1-8: The back panel of the control box**

### 1.5.3 Sound signals

Apart from the light indication on the front panel, the control box produces beeping signals to indicate certain system events as described in **Table 1-9**.

**Table 1-9: Sound signals of the control box**

System event	Signal
At initialization, to signal successful bootup of the operating system on the PC module	One beep

To signal that initialization of the motors in the arm joints is completed successfully
---

One beep
----------

## 1.6 Emergency stop button

The emergency stop button is a standalone device pre-assembled with a connection cable. The button enables Category 1 Stop in accordance with ISO 10218-1—controlled shutdown when power is supplied to the servos in the arm joints until full stop is achieved.



Figure 1-9: The emergency stop button



*The actual appearance of the emergency stop button can differ from that shown in Figure 1-9.*

Each robotic arm must have its own emergency stop button. You can place the button at any location within the operator's reach.

Use the button to immediately stop the robotic arm in an emergency, when other protective measures have proved to be impracticable or inefficient.

To resume operation of the robotic arm after an emergency shutdown, reset the system as described below:

1. Wait for the arm to come to a full stop. The LED on the arm wrist and the control box should go off completely.
2. Unpress the emergency stop button.
3. Flip the power switch on the back panel of the control box to the off position or unplug the power cord from the mains socket.
4. Switch the system on again as described in **Section 3.1**.



***Before restarting the system after an emergency shutdown, make sure the emergency stop button is unpressed. Otherwise, the system fails to start, causing the red LED on the control box to light up.***

## 1.7 Wrist

PULSE robotic arms are supplied pre-assembled with a **wrist**—a special flange for integrating an end effector.



*An end effector is a tool or a device designed to enable a robotic arm to perform various operations as required for its intended application. End effectors are beyond the scope of Rozum Robotics supply.*

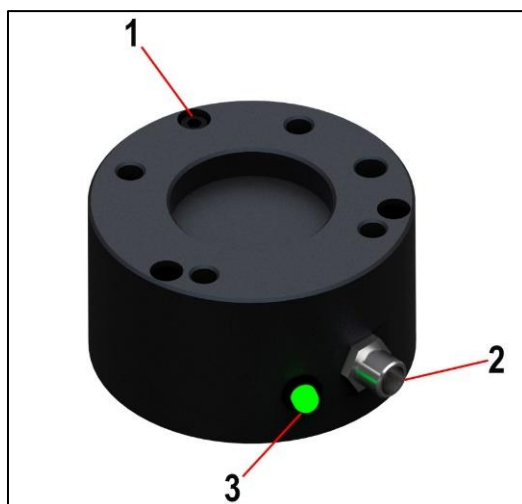

Figure 1-10: The wrist of the PULSE arm

The wrist of the PULSE robotic arm features:

- a standard ISO 9409-1-50-4-M6 mechanical interface **(1)**
- a cable output **(2)** for connecting an end effector electrically
- a LED indicator **(3)**



*When an installation requires a mechanical interface different from the standard ISO 9409-1-50-4-M6 one, the user (integrator) has to provide a proper adaptor for integrating an end effector.*

The states of the wrist LED are as described in **Table 1-10**.

Table 1-10: Arm states vs. LED signals

Arm state	LED signal
Power off	Off (no indication)
Standby mode (freeze state)	Green on
Operation (in motion)	Blinking green
Learn mode	Steady yellow
Error	Steady red
A control button pressed	Blinking blue

## 1.8 Electrical connections of PULSE arms

### 1.8.1 Power connection

The power connection of the control box is in accordance with the IEC 60320-1 C14 standard. The electrical specifications are as indicated in **Table 1-11**.

**Table 1-11: Electrical specifications of the control box power connection**

Parameter	Value/ range	Unit
Input voltage	100–264	VAC
Mains frequency	47–63	Hz
Standby power	10	W
Average operating power	400	W



*For enhanced safety, consider installing an external mains switch with a fuse.*

### 1.8.2 Digital I/O connectors

The control box has four digital inputs and two digital outputs. You can use them to connect additional equipment, including sensors, safety devices, PLC, etc. The connectors are located on the back panel of the control box (see **Figure 1-8**).



*The cable length from the digital inputs/ outputs to connected equipment should not exceed 2 m. Otherwise, signal quality may suffer.*

For the current control box configuration, the two lower digital I/O connectors have the RESERVED status. The pin assignment for the two upper ones is as illustrated in **Figure 1-11**.

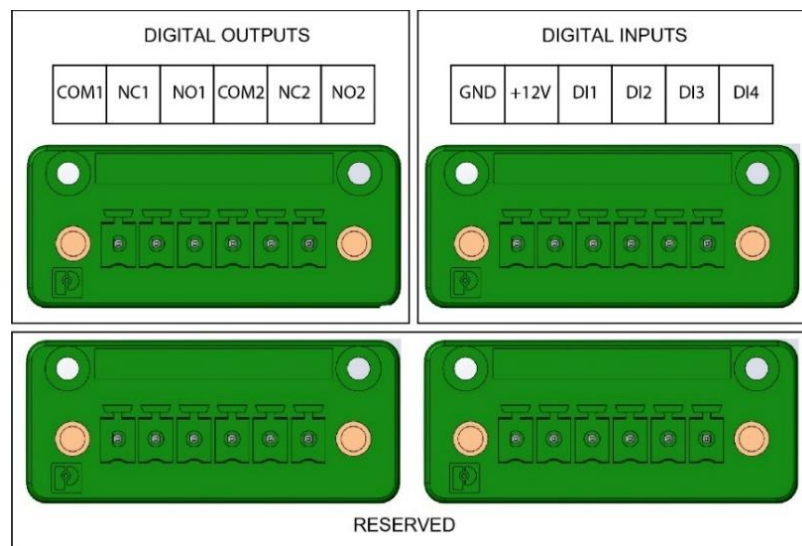

**Figure 1-11: Pin assignment for digital I/O connectors**

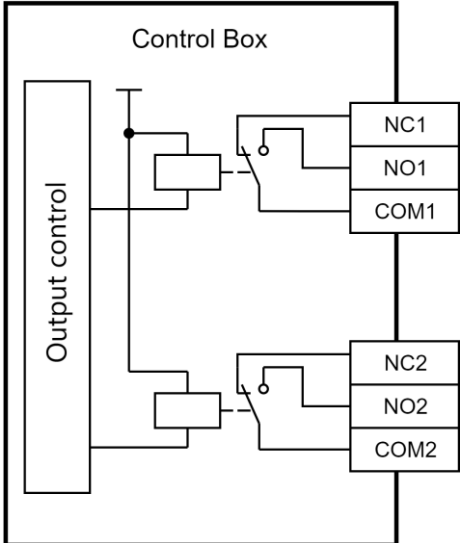

**Table 1-12: Specifications of relay outputs**

Relay output 1	Relay output 2	Description	Specifications
COM1	COM2	Common	 <p>Contact capacity: 48 V, 0.5 A</p>
NC1	NC2	Normally closed	
NO1	NO2	Normally open	

**Table 1-13: Specifications of digital inputs**

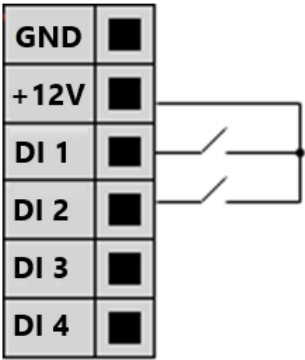

Digital input	Description	Specifications
12 V DC	Power for an external device	Max current load: 1 A <b>Warning! Connecting inductive load can cause damage to equipment!</b>
GND	Ground, 0 V	
DI1, DI2, DI3, DI4	Digital input	Max permissible current: 35 mA Input voltage range (Hi level): 5-12 V Input voltage range (Low level): 0-1.5 V 



## 1.9 States and modes of PULSE arms

### 1.9.1 Normal states and modes

**Table 1-14** describes the normal states and modes of PULSE arms. Transition from INITIALIZATION to READY is automatic, whereas from READY to WORK and back— are software-enforced.

**Table 1-14: The states and modes of the PULSE robotic arm**

State	Details
INITIALIZATION	<p>Power is supplied to the robotic arm via the cable connecting it to the control box. The arm is initializing.</p> <p> <b>Do not move the arm manually during initialization!</b></p> <p><b>Important!</b> During the initialization, watch carefully the LED indicators on the control box and the arm wrist.</p> <p><b>A. In case the initialization is in good progress</b>, the green LED on the control box is blinking, while the LED on the robotic arm is off.</p> <p><b>B. In case a problem occurs during the initialization</b>, the red LED on the control box lights up.</p>
READY	<p>The robotic arm is on, but not moving. It is in the Freeze state. The LED on the arm wrist is steady green. The green LED on the control box is constantly on.</p> <p> <b>In the FREEZE state, an attempt to move the arm by hand guiding can cause damage to its components.</b></p> <p> <b>When twists are detected during initialization (see Section 1.9.3), the arm changes over to the RELAX state so that users could move the arm manually. Simultaneously, the wrist LED starts blinking red.</b></p> <p>You can now initialize the PULSE DESK software (see <b>Section 4.1</b>) or get access to the API (see <b>Section 6</b>) or the sandbox (see <b>Section 7</b>).</p> <p>If you are initializing the PULSE DESK software for the first time, the arm changes over to the LEARN mode as soon as the starting page of the software is displayed on the screen. Subsequently, the LEARN mode is enabled whenever you create a new program (see <b>Section 5.1.1</b>).</p>

<p><b>READY (cont'd)</b></p>	<p>Once the LEARN mode is on, the control buttons are enabled, and the wrist LED turns yellow. In the mode, an arm is either:</p> <ul style="list-style-type: none"> <li>• <b>In the Freeze state:</b> The arm joints are locked in their current positions, and the user cannot move them by hand. The <b>Freeze state</b> is on by default.</li> <li>• <b>In the Free Drive (Zero Gravity) mode:</b> The arm joints become moveable, and users can change their positions by hand guiding. To enable/ disable the mode, press the <b>FREE DRIVE MODE button</b> (see <b>Figure 1-4</b>). When the mode is enabled, the wrist LED turns blue.</li> </ul> <p> <b><i>In the Free Drive mode, arm joints are not locked. To avoid accidental damage, never leave the arm unattended, providing proper support with your hands.</i></b></p>
<p><b>WORK</b></p>	<p>This is a state of active operation, when an arm moves or performs any other programmed actions (e.g., closes/ opens the gripper).</p> <p>The green LED on the front panel of the control box is constantly on, and the wrist LED is blinking green.</p> <p> <b><i>Keep away from the arm workspace (Section 1.4.3), while the arm is in the WORK state.</i></b></p>

### 1.9.2 Emergency state

During operation, the arm can changes over to the Emergency state **due to a fatal or non-fatal error**. **Table 1-15** below describes related indication and states of PULSE arms, as well as recommendations how to respond.

**Table 1-15: Indication and user response in an emergency state**

<p><b>When the error is non-fatal...</b></p>	<p>The wrist LED turns red. On the control box, the red LED is steady on, while the green LED is blinking. PULSE DESK, if started, displays an emergency state warning.</p> <p><b>User actions:</b></p> <ol style="list-style-type: none"> <li>1. Eliminate the cause of the error (e.g., an obstacle).</li> <li>2. In the warning dialog, click <b>Recover</b>.</li> </ol>
--	---

<p><b>When the error is fatal...</b></p>	<p>On the control box, the red LED is steady on, while the green LED is blinking. The wrist LED goes off since the arm is de-energized and switches to the RELAX state.</p> <p> <b><i>In the RELAX state, the arm cannot retain its current position.</i></b></p> <p><b>User actions:</b></p> <ol style="list-style-type: none"> <li>1. Find out and eliminate the cause of the fatal error.</li> <li>2. Switch the arm off and then back on by flipping the power switch on the back of the control box. If the arm fails to resume normal operation after rebooting, contact the vendor's Service personnel.</li> </ol>
--	--

### 1.9.3 Untwisting mode

The arm changes over to the untwisting mode after an emergency shutdown if a *twist* is detected for one or more motors in its joints during initialization. A *twist* is when a motor has made more than one 360° turn.



***Multiple twists can lead to wire breaks and other irreparable damages.***

As soon as a twist is detected, the arm changes over to the RELAX state, when users can move the arm manually. The wrist LED starts blinking red. **Access to the PULSE DESK interface is disabled**, whereas the REST API functions for moving the robot become unavailable.



*The REST API functions for reading arm parameters remain available even in the untwisting mode.*

Simultaneously, a twist detection alert appears on the screen (see **Figure 1-12**).

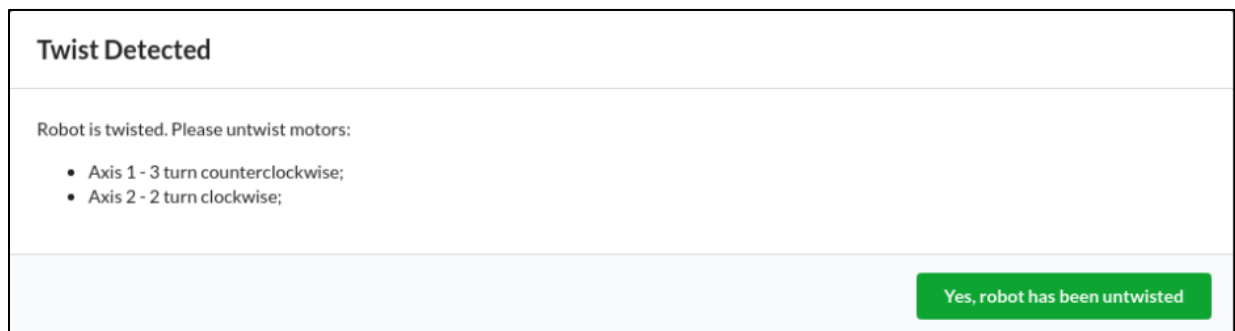

Figure 1-12: PULSE DESK twist detection alert

In the alert, you get the following information:

- which axis (one or more) has a motor with a twist (for axis numbers, see **Figure 1-13**)
- how many turns to make to untwist the axis (axes)
- in which direction to make the turns



*If a twist detection alert instructs “Axis 1 — 3 turn clockwise,” this means that you need to untwist Axis 1 by rotating it 360° three times in the clockwise direction.*

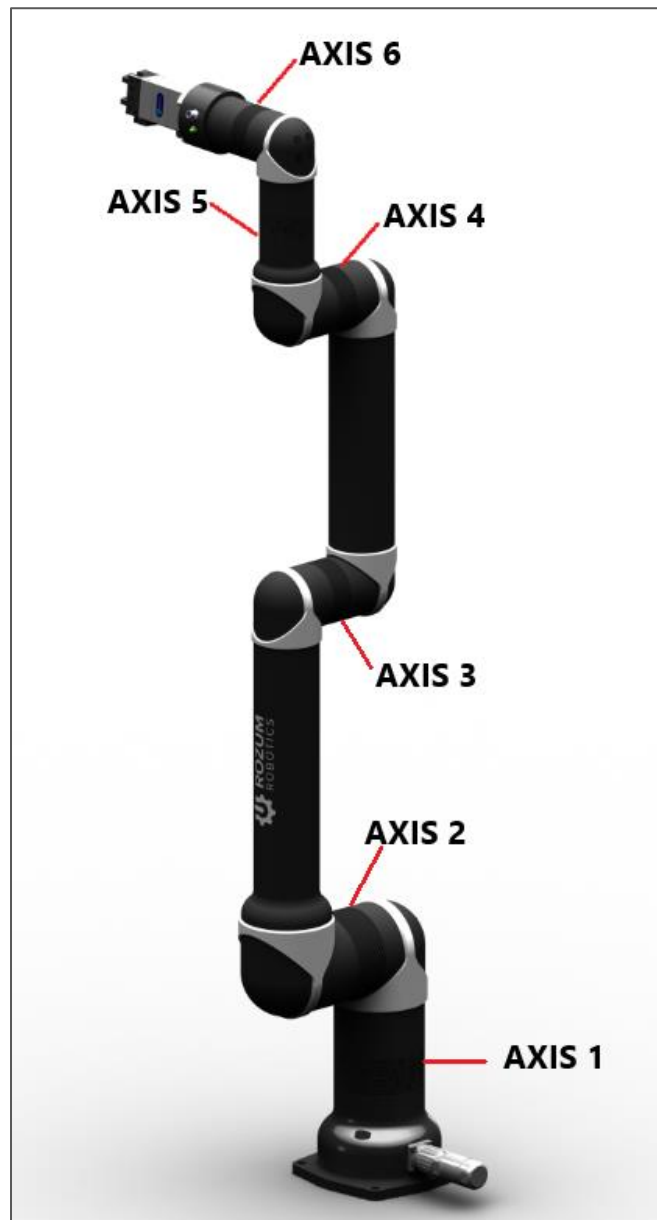

**Figure 1-13: PULSE arm axes**

To get back to the operation mode from the untwisting one, follow the instructions below.

**If you controlling the arm via REST API:**

1. Rotate the axis (axes) with a detected twist manually as specified in the twist detection alert. For axis numbers, see **Figure 1-13**.
2. Send the **PUT/untwisting/finish** request to make sure you have completed the untwisting as appropriate (for details of using the command, refer to the [REST API Reference Guide](#)).

If the command response is:

- **OK** — untwisting is completed successfully, and you can go back to normal operation of the arm.
- **A twist detection alert** — untwist the arm manually once again as instructed in the alert and send another **PUT/untwisting/finish** request to check the untwisting results.

**If you are controlling the arm via the PULSE DESK interface:**

1. Rotate the axis (axes) with a detected twist manually as specified in the twist detection alert. For axis numbers, see **Figure 1-13**.
2. In the twist detection alert (**Figure 1-12**), click **Yes, robot has been untwisted** to confirm you have untwisted the axis (axes) manually as instructed.

If you have untwisted the robot as appropriate, the twist detection alert disappears from the screen.

If you have failed to eliminate the twist or act as instructed, the alert remains on the screen. You need to untwist the arm once again in accordance with the instructions in the alert.

## 1.10 Safe operation requirements



***Make sure to read and meet the requirements before operating an arm.***

To ensure safe operation of a PULSE arm, it is essential to comply with the following requirements:

- **Conduct a risk assessment** of your application to evaluate the need for additional safety devices (e.g., safety cages, fencing, etc.) or any other risk-mitigating measures.
- **Provide continuous power supply** to the robotic arm (e.g., installing an uninterruptible power supply, a redundancy circuit, etc.). Otherwise, we cannot guarantee that the robotic arm maintains its position during a power outage, which may result in serious damage.
- **Keep away from the workspace** of the arm when it is in the WORK state.

---

## 2 INTEGRATING INTO AN APPLICATION

### 2.1 Preparatory works

Before integration, carry out the following preparatory works:

1. Unpack the robotic arm and other components.
2. Check the supply package against the list in **Section 1.2**.
3. Check the appearance of the arm and its components for any damages or defects.



*If you find any obvious damages or defects or find out that any of the supply package components are missing, contact the dealer or the manufacturer.*



***When unpacking and installing an arm, avoid moving or rotating arm joints manually because this can cause damage to the arm.***

To integrate a PULSE robotic arm into a user application, complete the following steps:

1. Mount the arm (see **Section 2.2**) and the control box (see **Section 2.3**).
2. Connect arm components, the network, and external equipment (if any) (see **Section 2.4**).
3. Mount an end effector (see **Section 2.5**).
4. Verify the installation by conducting pre-commissioning checks (see **Section 2.6**).

### 2.2 Mounting an arm



***Pinching hazard! When performing mounting works, keep your fingers away from the arm joints to avoid entrapment. Do not wear loose clothing or jewelry. Make sure long hair is tied back.***

Though the footprint of PULSE robotic arms is as small as 120 mm, you need to account for the arm workspace (**Figure 1-6**) when choosing a mounting location. This is important to exclude collisions with other equipment or objects.

The recommended mounting position for a PULSE arm is **vertical**, on a **horizontal immovable surface**. The mounting surface should be:

- flat, solid, and stable
- sustain 8 times the weight of the robotic arm (see **Table 1-3**)

The installation procedure includes the following steps:

1. Position the arm vertically.
2. Holding the arm tight, secure it on a mounting surface using one of the following methods:

#### **Method 1.**

- Insert 4 M8 bolts into the four 9-mm dia. holes on the transition plate (see **Figure 2-1**) and tighten the bolts as appropriate.

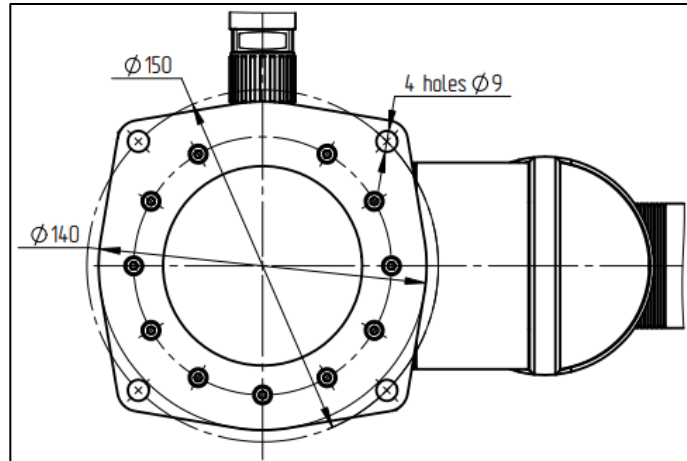

**Figure 2-1: Mounting the arm by Method 1**

### Method 2.

- Since the arm is supplied pre-assembled with a transition plate, your first step is to dismantle the plate. To do this, unscrew the 2 pins and 11 bolts holding the arm base and the transition plate together.
- Use the 2 pins and 11 bolts (see **Figure 2-2**) to screw the arm base down to your mounting surface without a transition plate.

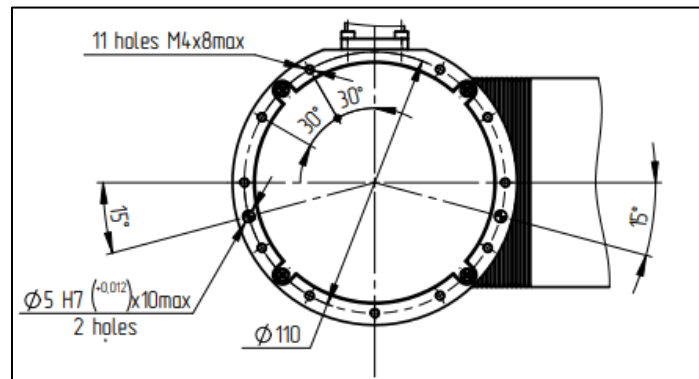

**Figure 2-2: Mounting the arm by Method 2**

## 2.3 Installing a control box

There are three methods to install a control box:

- horizontal positioning on a flat solid surface (e. g., a table)
- vertical positioning using a specially designed stand
- rack mounting (DIN 19") (for location of rack mounting holes, see **Figure 1-8**)



**When installing the control box, provide an air gap of 50 mm from its front and back panels.**



The exact installation method depends on the particular operating environment of the PULSE arm and your requirements. In any case, the distance from a control box to an arm should not exceed 3 meters—the length of the connection cable. Otherwise, you will have to use a cable extension.

## 2.4 Connecting the arm components, the network, and external devices



***Before proceeding to connect the arm, make sure no power is supplied to the robotic arm or the control box.***

To provide the required connections, follow the sequence of steps as below:



***Always use the original cables included in the supply package!***

**Step 1.** Connect the arm with the control box using the 48V hybrid cable from the supply package as described below:



***Always use an arm with a control box from the same supply package! Otherwise, the arm will not start.***

1. To connect the cable correctly, match the marks on the cable connector and on the control box connector as shown below.

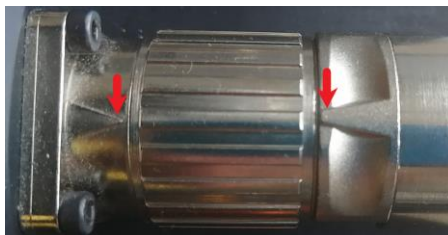

2. Screw the connector down as far as it will go. The figure below illustrates a correctly secured connector.

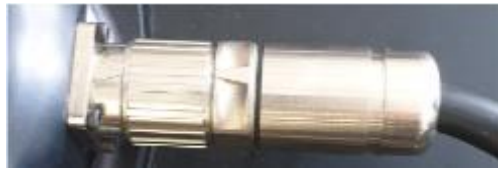

**Step 4.** Plug the emergency stop button cable into the appropriate connector on the back panel of the control box.



**Step 5.** (*Optional*) Connect any required additional equipment (e.g., a sensor, a safeguard, a PLC) to the control box, using the digital I/Os on its back panel. For detailed instructions and requirements, see **Section 1.8.2**.



**Step 6.** Connect the arm to a computer directly or to a local network, using an Ethernet cable.



**Step 7.** Connect the control box to a power supply (a mains network) using the 220V power cable included in the supply package. The power supply connector is located on the back panel of the control box.



## 2.5 Mounting an end effector

Depending on particular needs, you can use different end effectors with PULSE arms. Possible options include grippers for pick-and-place operations, material removal tools for cutting, drilling, and deburring, welding torches, etc.

**i** *Selecting a proper type and model of an end effector is the responsibility of the integrator.*

To attach an end effector to the robotic arm, use the mechanical and electrical interfaces on its wrist (see **Figure 1-10**). In its basic design, the wrist of the PULSE robotic arm has the standard ISO 9409-1-50-4-M6 mechanical interface as shown in **Figure 2-3**.

**i** *For more details, refer to the dimensional drawing, which is available for downloading at the web page: <https://rozum.com/robotic-arm/#pulse-documentation>.*

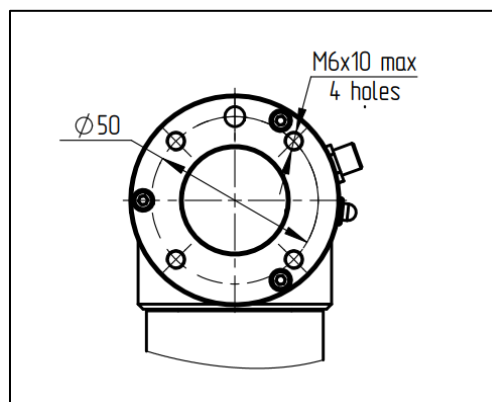

**Figure 2-3: Basic mechanical interface on the arm wrist**

**i** *In case your end effector has a mechanical interface different from the standard ISO 9409-1-50-4-M6 one, make sure to use an appropriate adaptor.*

The **basic electrical interface** of the arm wrist is a socket as shown in **Figure 2-4**.

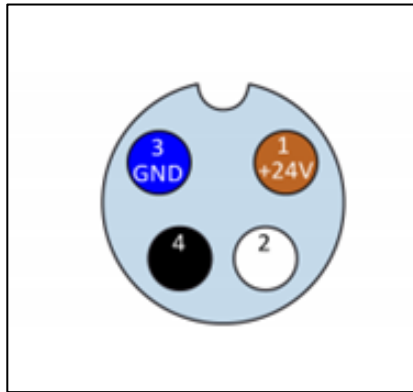

**Figure 2-4: Basic electrical interface on the arm wrist**

The pin assignment in the socket is as described in **Table 2-1**.

**Table 2-1: Pin assignment in the end effector socket**

Pin	Wire color	Signal
1	Brown	+24V
2	White	Digital output 1
3	Blue	GND
4	Black	Digital output 2

**Figure 2-5** below is the electrical diagram for the digital outputs in the end effector socket on the wrist. Make sure to observe the specified parameters when selecting and connecting an end effector.

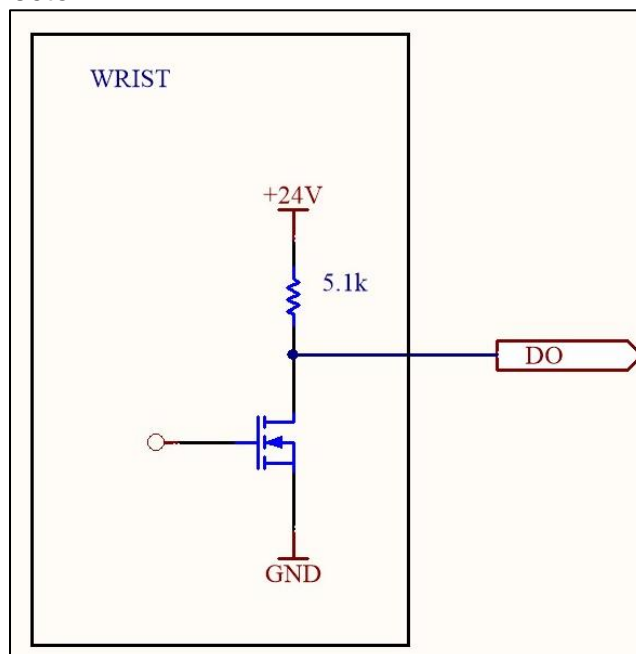

**Figure 2-5: Electrical diagram for the digital outputs of the end effector socket**

## 2.6 Pre-commissioning checks

Once you have integrated the PULSE robotic arm system into your application as described in previous sections, you can proceed to commissioning the system and actually working with it. Before the initial and any subsequent starts, make sure to check the following:

- The robotic arm is fixed securely on a sturdy mounting surface and can remain stable during operation.



***If the fittings of the robotic arm are not tight enough and the mounting surface is not sufficiently sturdy, the robot can fall over during operation and cause an injury.***

- The end effector is securely attached to the arm wrist and will not fall out during operation.
- All cables are intact, connected to appropriate connectors, and properly secured.
- The emergency stop button is attached to the control box and is located where the operator can reach it from his/her workplace at any moment.
- The operating conditions comply with the requirements as set forth in **Section 1.3**.
- All risks identified during a risk assessment of the operating environment have either been eliminated or mitigated by implementing appropriate measures (e.g., safeguards, limiting access to the arm workspace).
- There are no obstacles within the workspace of the robotic arm that could prevent the arm from moving freely or operating properly.

Now, the PULSE arm is ready for switching in accordance with **Section 3.1**.

## 3 GETTING STARTED WITH THE ROBOTIC ARM

### 3.1 Switching the arm

**Important!** Before you switch the PULSE robotic arm, it must be ready for operation, i.e.:

- mounted at its operating location
- connected to the control box, the work tool, the emergency button, and additional equipment (if any)
- connected to your local network
- pass pre-commissioning checks

To switch the PULSE robotic arm, follow the instructions below:

1. Plug the power cord of the control box into the mains socket.

- Flip the power switch (see **Figure 3-1**) on the back panel of the control box to the ON position.

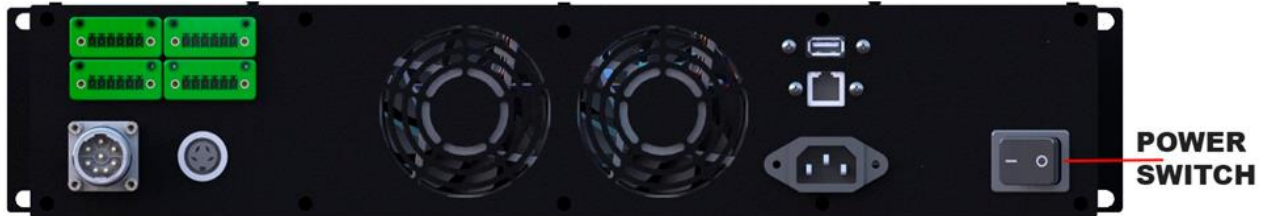

Figure 3-1: The back panel of the control box

The control box starts receiving power and initializing. During the initialization, the green LED on the control box is blinking, while the LED on the arm wrist is off.



*When the red LED on the control box lights up during the initialization, this indicates an error. Flip the power switch on the control box to the off position and wait for the indicators on the front panel to go off completely. Then, make sure the emergency shutdown button is unpressed and robot connections are correct and secure, switch the arm back on. See also **ANNEX III. TROUBLESHOOTING.***

Once the initialization of the control box is over, the robotic arm starts initializing, too. When the arm is fully initialized and ready for operation, the wrist LED turns steady green.



***Do not move the arm manually until the initialization is over and the wrist LED on the arm is steady green!***

After you initialized the arm, you need to set communication between the arm and a PC or another control device as detailed in **Section 3.2**.

## 3.2 Setting communication with the PULSE arm

To set communication with a PULSE arm, you can use:



- a **static IP address**, if you connect the arm directly to a control device (a PC) or to a network without a DHCP server
- a **dynamic IP**, if the arm is connected to a network with a DHCP server

### 3.2.1 Static IP

**By default**, the PULSE robotic arm is set to the following **static IP address** — **10.10.10.20**. To set a PC to work with the static IP address, follow the instructions below, depending on the operating system in use.

## Windows OS

1. Switch on your PC.
2. In the right corner of the Taskbar, left-click the network connection indicator.

 *When the network connection indicator is not on the Taskbar, try the Wi-Fi indicator .*



3. Select an active Ethernet connection next to the network connection indicator. The connection name can differ, depending on your network settings.

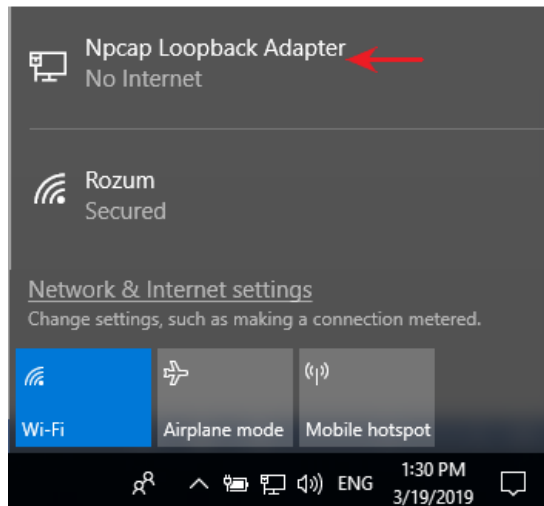

4. In the displayed Ethernet settings window, click **Change adapter options**.

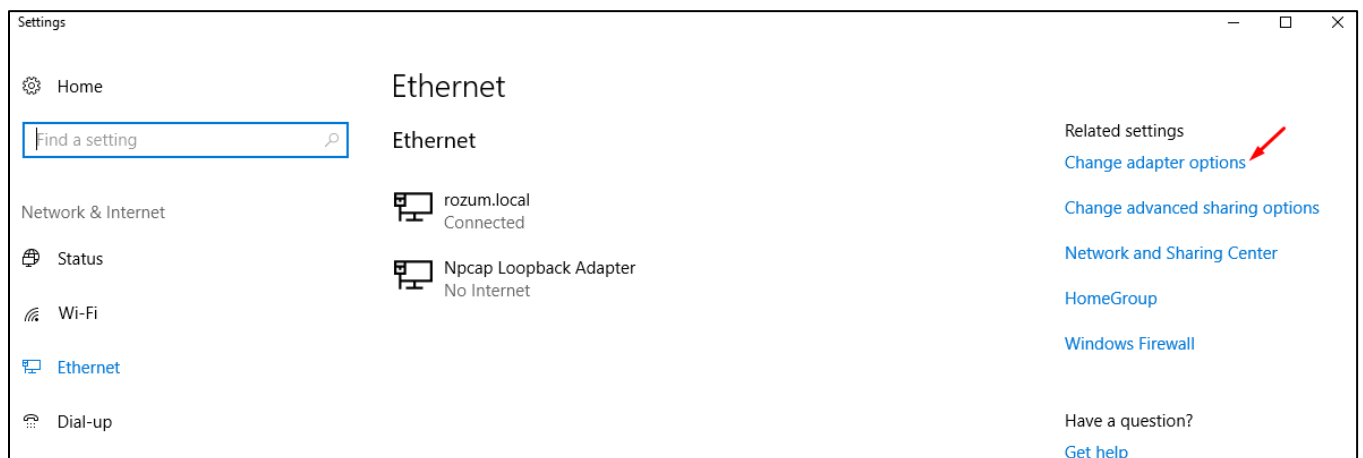



5. In the displayed **Network Connections** window, right-click the **Ethernet** icon and select **Properties**.

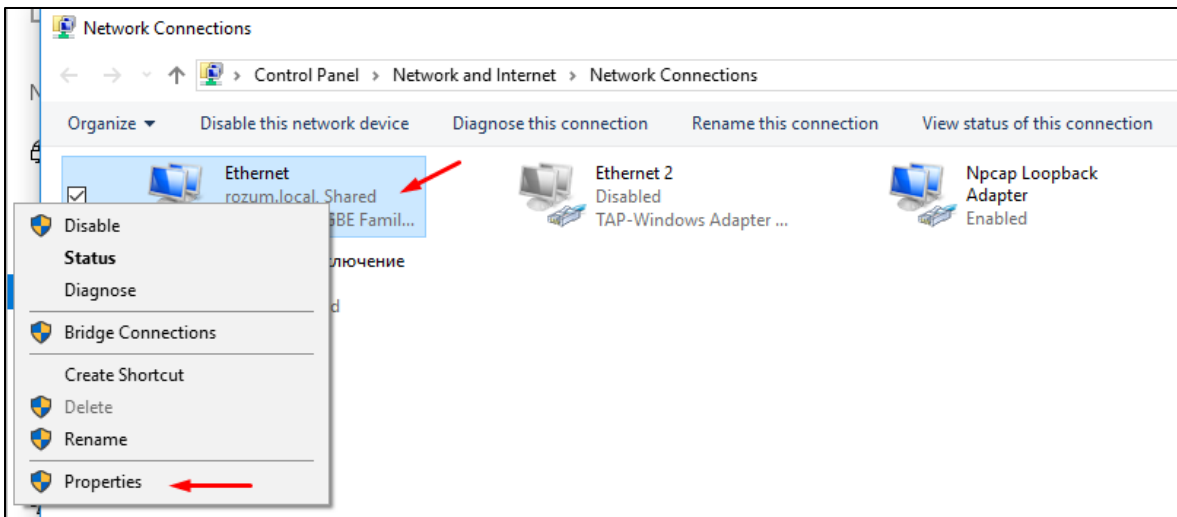

6. On the **Networking** tab in the displayed **Ethernet properties** window, double-click **Internet Protocol Version 4 (TCP/IPv4)**.

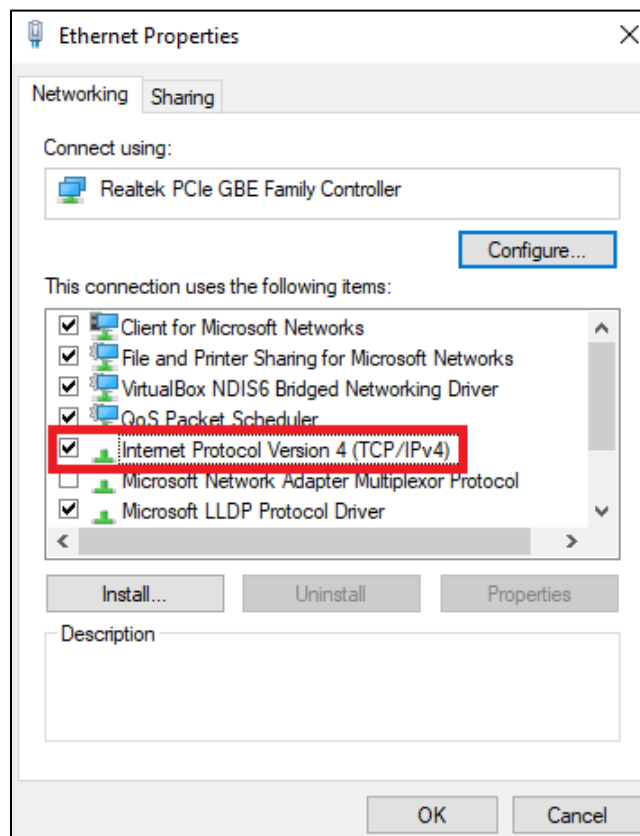



7. In the **IP Version 4 (TCP/IPv4)** window, select **Use the following IP address** and set up the **IP address** and the **Subnet Mask** fields to the value as shown below.



To specify the last IP address digit in the IP address field, you can use any value from 1 to 255, except for 20 since 10.10.10.20 is the default static IP address of the arm.

IP version 4 (TCP/IPv4) Properties

General

You can get IP settings assigned automatically if your network supports this capability. Otherwise, you need to ask your network administrator for the appropriate IP settings.

Obtain an IP address automatically

Use the following IP address:

IP address: 10 . 10 . 10 . 1

Subnet mask: 255 . 255 . 255 . 0

Default gateway: . . .

Obtain DNS server address automatically

Use the following DNS server addresses:

Preferred DNS server: . . .

Alternate DNS server: . . .

Validate settings upon exit

Advanced...

OK Cancel

8. Click **OK** to confirm the settings.



***If you are going to use the same control device for other purposes than controlling the arm, we recommend restoring initial IP settings after you are done working with the arm. To accomplish this in the Windows OS, open the IP Version 4 (TCP/IPv4) Properties window, check Obtain an IP address automatically, and click OK to confirm.***

## Linux OS

1. Switch on your PC.
2. Open **Network Connections** and double-click **Ethernet** to open the editing window as shown below.

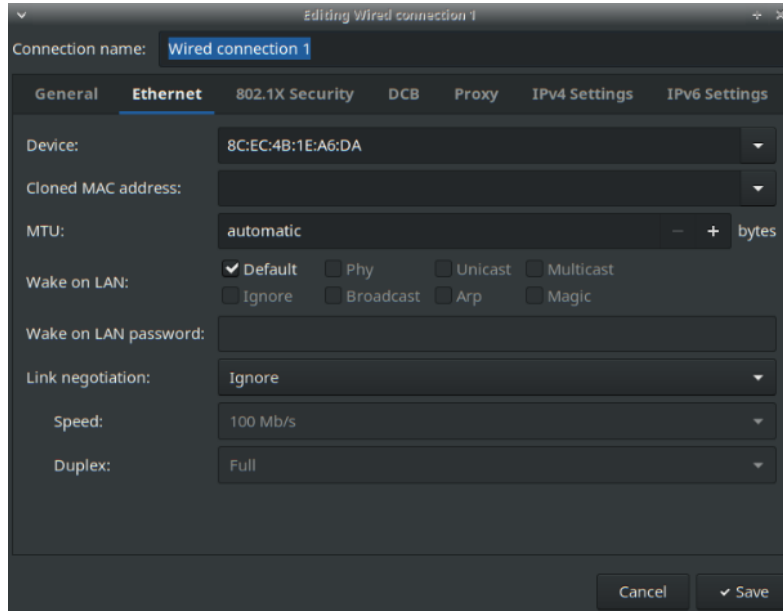

3. In the displayed window, select the **IPv4 Settings** tab.

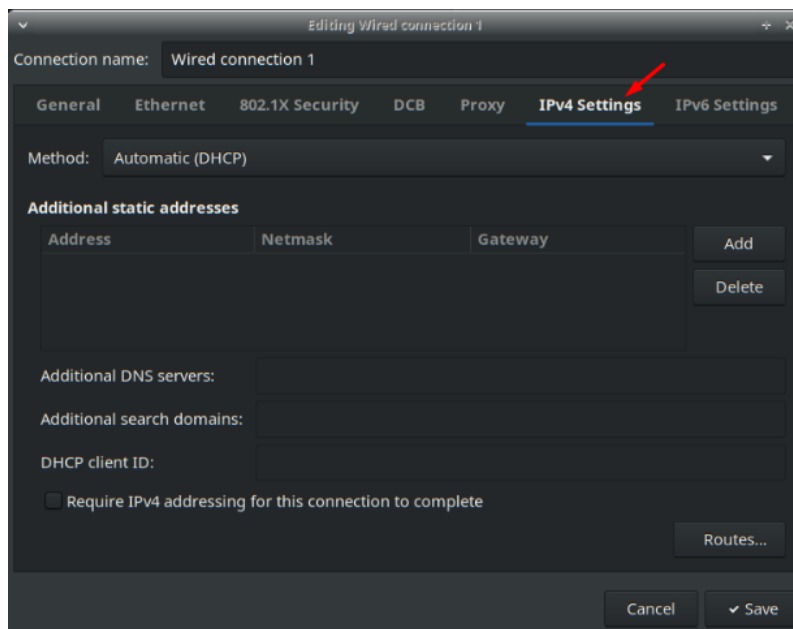

4. In the **Method** dropdown box on the **IPv4 Settings** tab, select **Manual**.

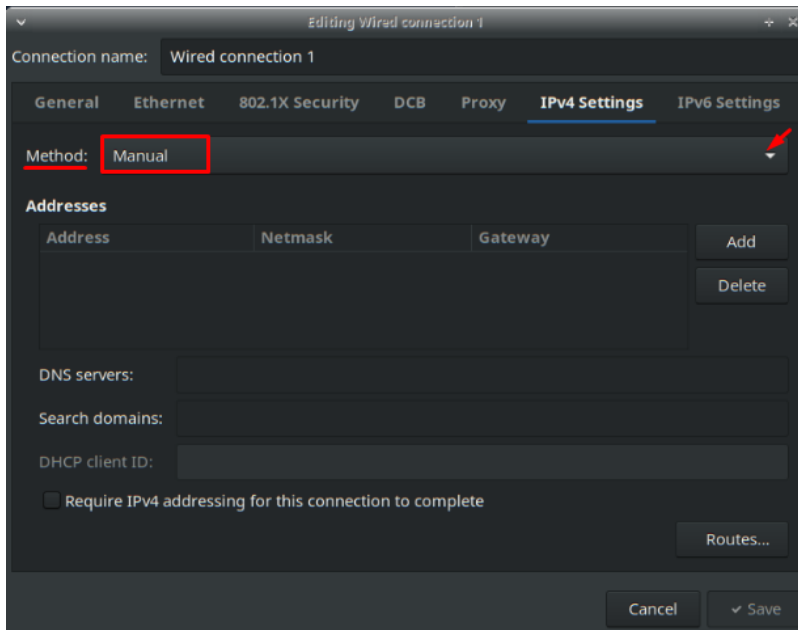

5. In the **Addresses** area on the same tab, click **Add** and specify the **Address**, **Netmask**, and **Gateway** as shown in the figure below.

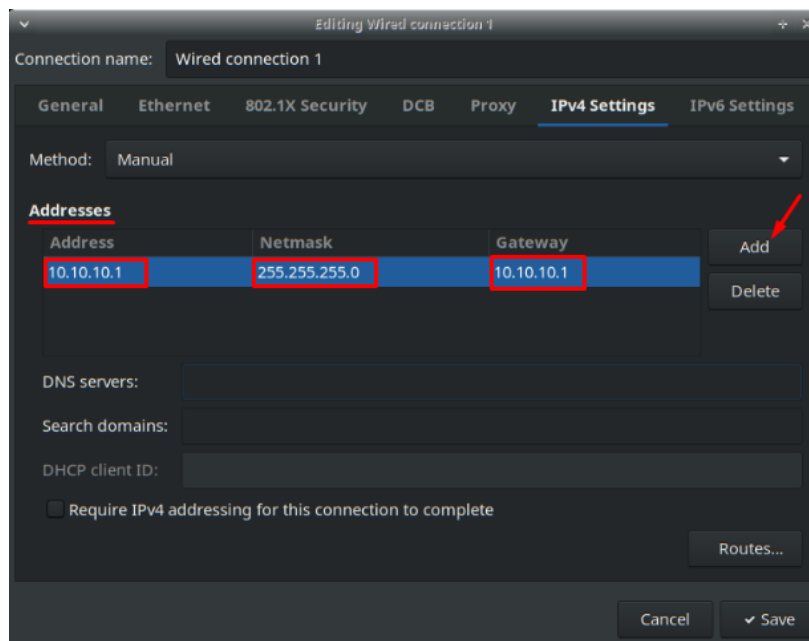

To specify the last digits in the Gateway and the Address fields, you can use any values from 1 to 255, except for 20, since 10.10.10.20 is the default static IP of the arm.

6. Click the **Save** button to confirm the settings.



***If you are going to use the same control device for other purposes than controlling the arm, we recommend restoring initial IP settings after you are done working with the arm. To accomplish this in Linux OS, open IPv4 Settings tab, select Automatic (DHCP) in the dropdown list of the Method field, and click Save to confirm the selection.***

### 3.2.2 Dynamic IP

Dynamic IP is the IP address of the PULSE arm assigned to it by a DHCP server in the user network. To find out the dynamic IP of the robotic arm in your local network, ask for assistance your system administrator and follow the instructions below:

1. Switch on your PC
2. Go to the [web page](#) and download **nmap** compatible with your operating system.
3. Install and start **nmap** on your PC.
4. In the **Command** line on the displayed **nmap** screen, specify the following:

```
nmap 192.168.0.1-255 -Pn -p2222,8080,8081 --open -oG - | awk
'/2222\//open.*8080\//open.*8081\//open/{print $2}'
```

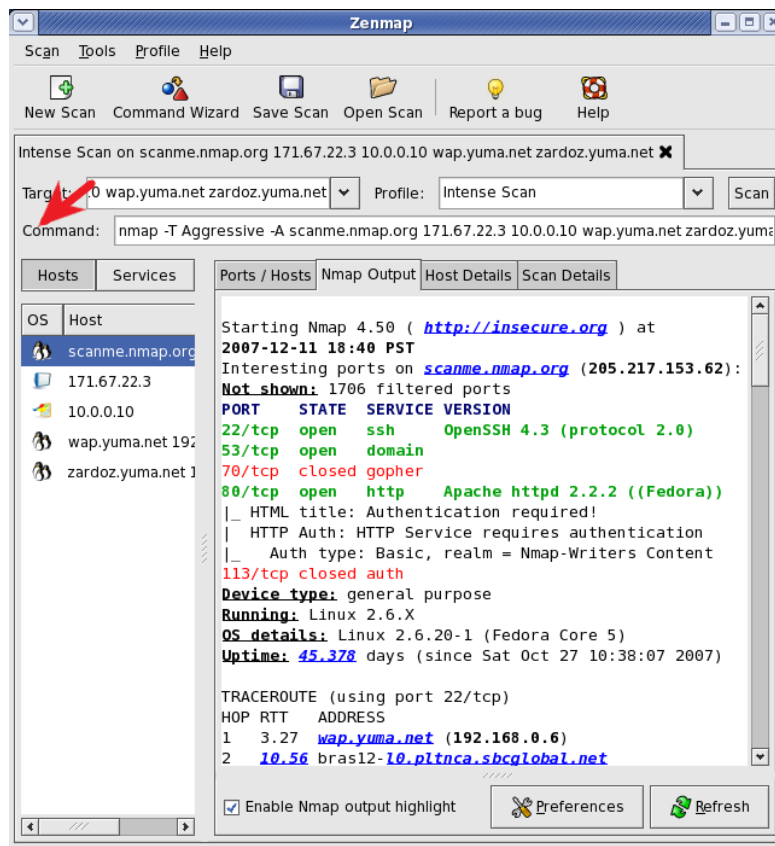

5. On the same screen, click **Scan**.

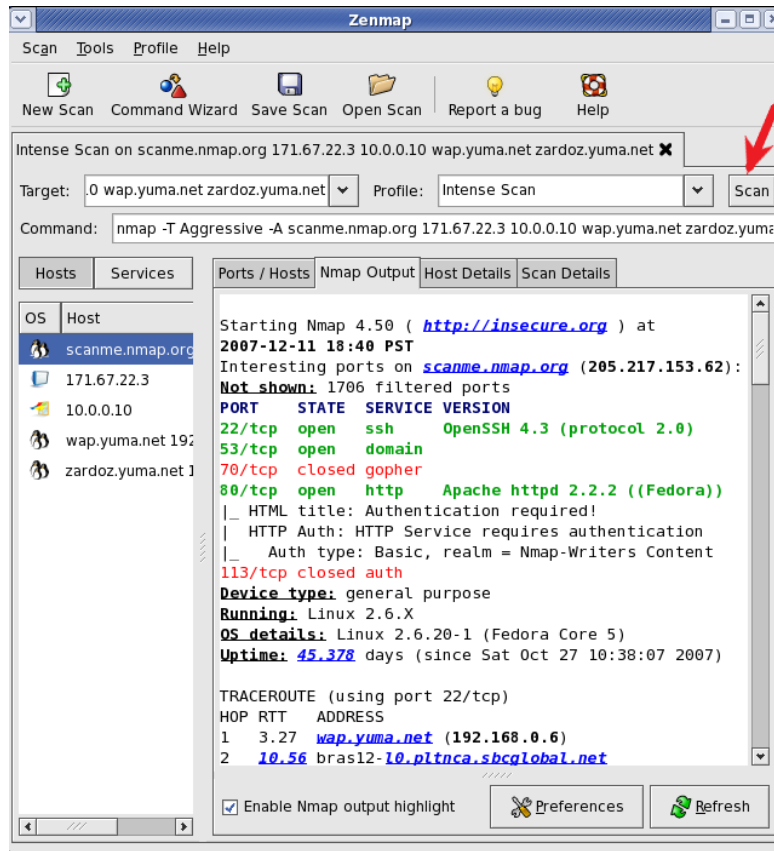

6. In the command output on the **Nmap Output** tab, find a port with the **open** status.

```
# Nmap 7.70 scan initiated Tue Mar 12 17:45:25 2019 as: nmap -p 2222,8080,8081 -oG - -oX c:\users\alesia-1.bul\AppData\Local\Temp\zenmap-qzpquc.xml -Pn --open
192.168.0.1-255 | awk /2222/open.*8080/open.*8081/open/{print $2}
Failed to resolve "|".
Failed to resolve "awk".
Unable to split netmask from target expression: "/2222/open.*8080/open.*8081/open/{print $2}"
Host: 192.168.0.24 () Status: Up
Host: 192.168.0.24 () Ports: 8080/open/tcp/http-proxy/// Ignored State: closed (2)
Host: 192.168.0.25 () Status: Up
Host: 192.168.0.25 () Ports: 8080/open/tcp/http-proxy/// Ignored State: closed (2)
Host: 192.168.0.63 () Status: Up
Host: 192.168.0.63 () Ports: 8080/open/tcp/http-proxy/// Ignored State: closed (2)
Host: 192.168.0.127 () Status: Up
Host: 192.168.0.127 () Ports: 8080/open/tcp/http-proxy/// Ignored State: filtered (2)
Host: 192.168.0.151 () Status: Up
Host: 192.168.0.179 () Ports: 2222/open/tcp/EtherNetIP-1///, 8080/open/tcp/http-proxy///, 8081/open/tcp/blackice-icecap///
Host: 192.168.0.200 () Status: Up
Host: 192.168.0.200 () Ports: 8080/open/tcp/http-proxy/// Ignored State: filtered (2)
Host: 192.168.0.201 () Status: Up
Host: 192.168.0.201 () Ports: 8081/open/tcp/blackice-icecap/// Ignored State: closed (2)
# Nmap done at Tue Mar 12 17:45:38 2019 -- 255 IP addresses (70 hosts up) scanned in 13.40 seconds
```

IP address of the arm in your local network

The IP address corresponding to the port is the IP address of the PULSE robot arm you are looking for.



*If you fail to find out the dynamic IP address of the arm, check the network connection settings. The arm may not have received the IP address from the DHCP server within the period as preset for the network, resulting in a fallback to the static IP 10.10.10.20.*

After you have set up communication with the arm, you can proceed to working with the PULSE DESK interface (see **Section 4**) or REST API (see **Section 6**).

## 4 THE PULSE DESK USER INTERFACE

PULSE DESK is a software program that enables operating the PULSE robotic arm together with an attached work tool. The program is pre-installed on the PC module integrated into the control box and boots in the course of the control box initialization. Its functionality allows for the following:

- creating programs to set up a motion trajectory of the robotic arm
- debugging created programs to adjust the motion trajectory
- executing created programs to operate the arm
- saving and deleting created programs
- adjusting the motion speed of the arm
- operating an attached work tool
- setting parameters for communication between the arm and external equipment (e.g., conveyor belts, safety devices)
- enabling/disabling control of the robotic arm via REST API
- saving data on program execution to a production log (available to service personnel only)

### 4.1 Accessing the PULSE DESK software

To access the software, complete the following two steps:

1. Open your preferred browser.
2. In the browser line, type in one of the following:
  - the static IP — either *localhost:8080* or *10.10.10.20:8080*
  - the dynamic IP address (see **Section 3.2.2**) assigned to the arm in your local network and the corresponding port number

If the attempt to connect to PULSE DESK is **successful**, the browser displays:

- PULSE DESK starting screen, if you start PULSE DESK for the first time; or
- **Edit** screen (see **Section 4.2**).



*At the start, the software also informs you about available updates (if any) (for updating instructions, refer to **Section 5.6**).*

## When PULSE DESK is unavailable

At the start of PULSE DESK, it may occur so that the user interface becomes unavailable. In this case, the following alerts appear on the screen:

- An emergency message stating that the user interface is unavailable. In this case, you need to disable API (for details, see **Section 6**).

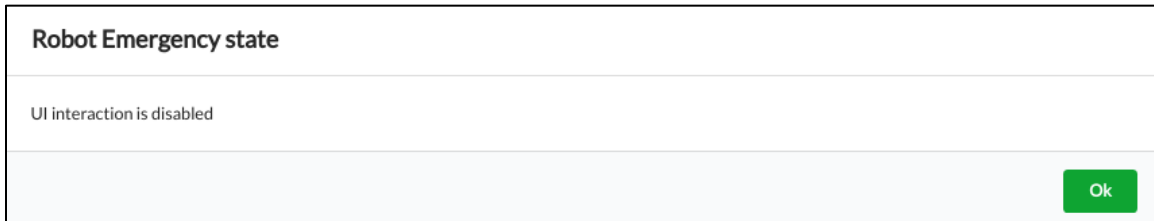

- A twisting alert, in which case the arm changes over to the untwisting mode and you have to eliminate motor twists manually (for details, see **Section 1.9.3**)

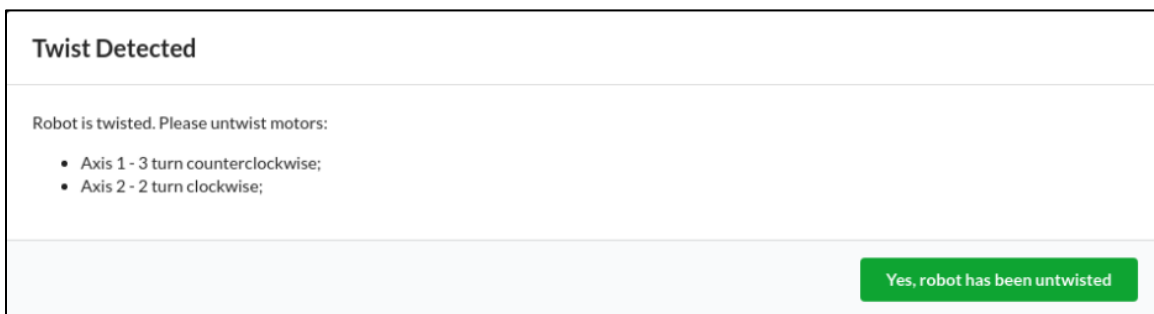

*When connection with the arm is lost, check the network connection settings. When you have trouble reconnecting or finding the arm IP, contact your network administrator or the service department.*

## 4.2 Edit screen

When you run PULSE DESK for the first time, you will see a starting page instead of the **Edit** screen. The starting page has only the **Main Menu** button and the **Program Name** field.

As soon as you begin creating a new program (see **Section 5.1.1**) from the starting page, PULSE DESK displays the rest of the screen elements as shown in **Figure 4-1**. At subsequent starts, the software loads the **Edit** screen with the last executed program.

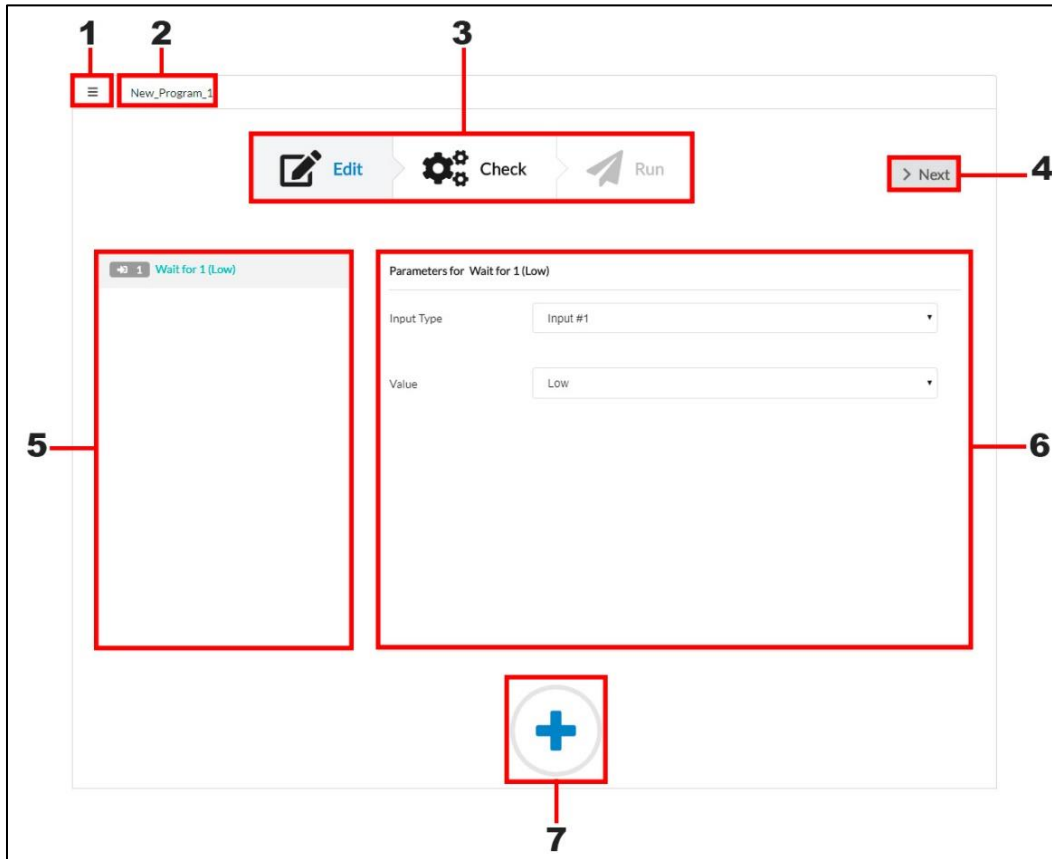





Figure 4-1: The Edit stage screen

Table 4-1 describes the interface elements of the **Edit stage** screen and their purposes.

Table 4-1: The elements of the Edit stage screen

No.	Description
1	<p>The <b>Main Menu button</b> opens the Main menu of the PULSE DESK software (for details, see <b>Section 4.1</b>).</p>
2	<p>The <b>Program Name field</b> displays either the name of the currently executed program or the default “<i>Program_Name_N</i>” name.</p> <p> <i>The Program Name field cannot be empty. If you remove the program name from the field, it will display the "Program name here..." background prompt.</i></p>
3	<p>The <b>Stepper</b> indicates the current stage of working with the PULSE DESK software:</p> <ul style="list-style-type: none"> <li>• creating a program (<b>Edit</b>)</li> <li>• debugging (<b>Check</b>)</li> <li>• production (<b>Run</b>)</li> </ul> <p>In the <b>Stepper</b>, you can see the currently active stage selected (as shown for the <b>Edit</b> stage in <b>Figure 4-1</b>) and the completed stage(s) (if any)—marked with a checkmark.</p>



4	<p>The <b>Next button</b> enables switching from programming to debugging and then to production.</p> <p>At the <b>Run stage</b>, PULSE DESK replaces the <b>Next button</b> with the <b>Save&amp;Run</b> one.</p>
5	<p>The <b>Program Body</b> panel displays the sequence of commands contained in a program. PULSE DESK indicates the currently executed command by selecting it.</p> <p>If you have just started PULSE DESK and chosen to create a new program, the <b>Program Body</b> contains only the <b>Wait for</b> command.</p> <p> <i>The <b>Wait for</b> command disappears as soon as you start adding new commands in the LEARN mode using the control buttons.</i></p>
6	<p>The <b>Service panel</b> displays the parameters of the command selected in the <b>Program Body</b>. You can set the parameters by changing the values in appropriate fields (see <b>Section 5.1.4</b>).</p> <p> <i>For the <b>Open gripper</b> and <b>Close gripper</b> commands, the <b>Service panel</b> is displayed empty.</i></p>
7	<p>The <b>Add Commands control</b> opens a list of commands for creating a program (for details, see <b>Section 5.1.2</b>).</p>

## 4.3 The Main Menu of PULSE DESK

Clicking the **Main Menu** button opens a sliding menu (see **Figure 4-2**) with the following commands:

- **Load program**—for choosing a program to work with from a list of previously created and saved programs
- **New program**—for creating a new program
- **Save program as**—for saving the program under a specified name
- **Delete program**—for permanently removing a program
- **Configure**—for enabling/ disabling remote control of the arm via REST API

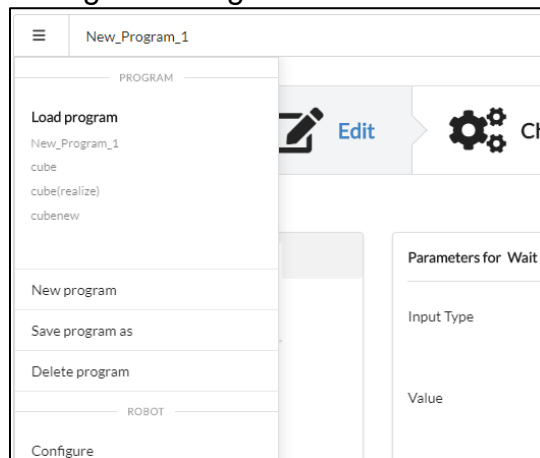
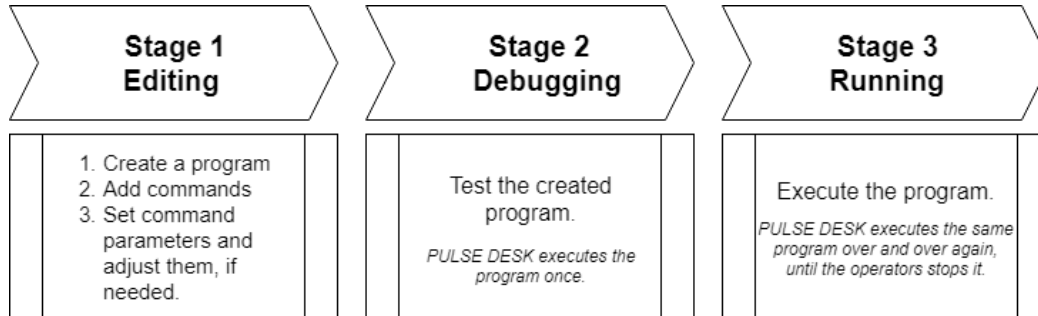

Figure 4-2: The Main menu of PULSE DESK

## 5 PROGRAMMING WITH PULSE DESK

The general workflow of the PULSE DESK software is as illustrated in **Figure 5-1**.



**Figure 5-1: The PULSE DESK workflow**

Until you complete the entire workflow up to the **Run** stage, switching from stage to stage is only possible in the consecutive manner by stage names in the **Stepper** or the **Next** button. Once you are at the **Run** stage, you can switch between the stages randomly by clicking the stage names in the Stepper — **Edit**, **Check** or **Run**.



*Before switching back from the Run stage to any other, it is advisable to stop program execution.*

### 5.1 Completing the Edit stage

#### 5.1.1 Creating a program

To create a new program, follow the instructions below:

1. On the **Edit** stage screen, click the **Main menu button** to open the **Main menu**.
2. On the **Main menu**, select **New program**. The arm switches to the LEARN mode, enabling the control buttons. The LED on the arm wrist turns steady yellow.



*If you start PULSE DESK for the first time, the arm goes to the LEARN mode as soon as the starting page appears on the screen.*

3. On the **Main menu**, select **Save program as**, specify a program name in the displayed dialog box and confirm the changes by clicking **Yes**.

Save changes

---

Save this program as

Pick-and-place

No
Yes

**Figure 5-2: The “Save changes” dialog box**



*In PULSE DESK, every program should have a unique name. If you attempt to save a newly created program under a name that coincides with an already existing one, PULSE DESK displays an appropriate warning, preventing you from using the redundant name.*

If there is a program already running in PULSE DESK when you select **New program** on the **Main menu**, PULSE DESK requests to stop execution of the program. Once you confirm the stop, the software clears the **Program Body** panel and the **Program Name** field. You can proceed to create a new program as described above.

### 5.1.2 Adding commands to a program body

After you have created a program, the next step is to add commands to its body. The PULSE DESK software enables using the following commands:

- The **Wait for** command defines the type of the input signal (high/ low) that the arm should receive from external equipment before moving on to execute the next command. With the command, you also set the input port where the external equipment is connected.

For example, the input signal can be pressing an external button connected to a digital input on the control box.

- The **Send to** command defines the type of the output signal (high/ low) that the arm should send to external equipment and the output port to which the equipment is connected.

For example, the output signal can be a signal causing a conveyor belt connected to a digital output on the control box to switch on and move away a load.

- The **Delay** command specifies how long (in seconds) PULSE DESK should wait before moving on to execute the next command in the program body.
- The **Point** command sets a waypoint in a motion trajectory of the arm.
- The **Open gripper** command opens the gripper.
- The **Close gripper** command closes the gripper.



*Adding commands is possible only at the Edit stage.*

There are two ways to add commands to a program body:

- A. Using the **Add Commands** button
- B. Pressing the control buttons on the elbow fitting

### Method A

To add a command using the **Add Commands** button, follow the instructions below.

1. On the **Edit Stage** screen, click  to open the **Add Commands** menu.

The button  changes its appearance to .

 Use the  button to close the Add Commands menu when you no longer need it.

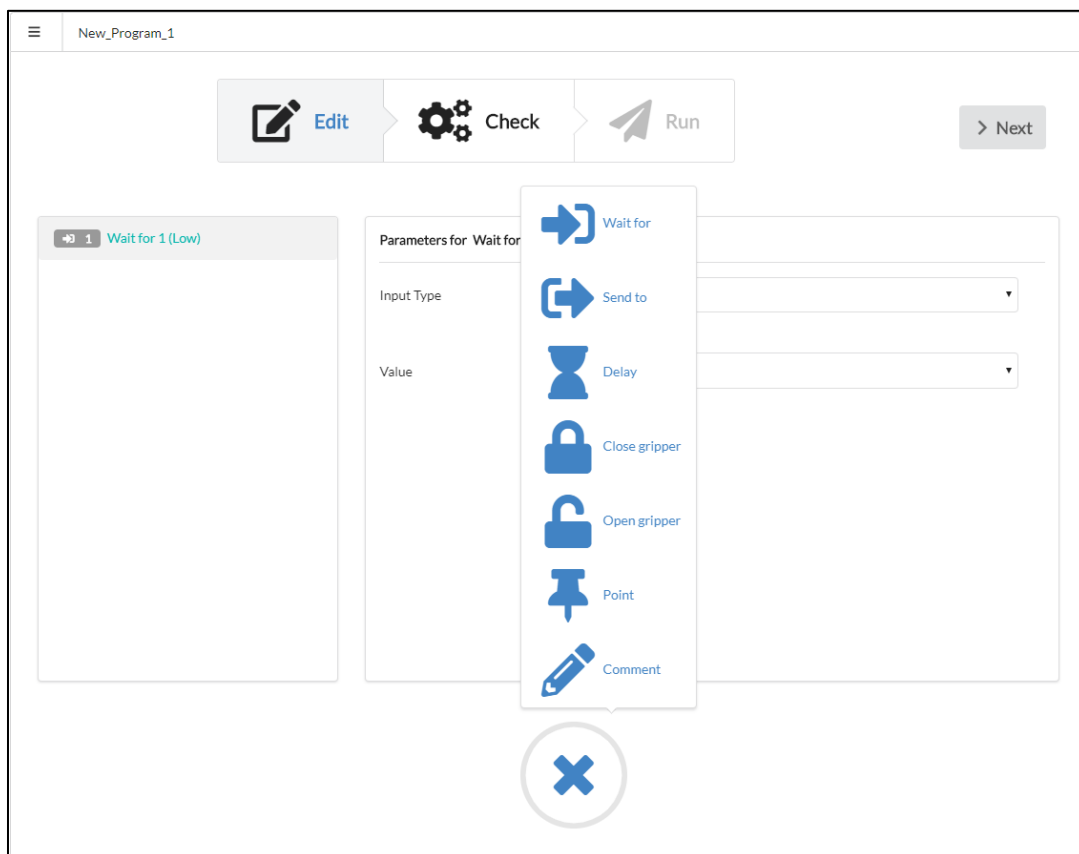

Figure 5-3: The Add Commands menu (opened)

2. On the **Add Commands menu**, click the required command. It appears in the **Program Body** below the currently selected command.

---

Now, you can set the command parameters (see **Section 5.1.4**) or to add another command.

### Method B

To add a command by pressing the control buttons, keep to the following guidelines.



*The control buttons are enabled in the LEARN mode only. You can use them to add three of the six commands—**Point**, **Open gripper**, and **Close gripper**.*

- To add the **Point** command:

**Step 1.** Press the **Free Drive Mode** button on the elbow fitting. If the mode is enabled successfully, the wrist LED turns blue.

**Step 2.** Move the arm manually to the desired position.



***In the Free Drive mode, the arm joints are not locked. Make sure to hold the arm tightly, providing proper support.***

**Step 3.** Press the **Free Drive Mode** button again to disable the mode and fix the arm in the desired position.

**Step 4.** Press the **Point** button on the elbow fitting to add the position as a new point to the program body. A corresponding line appears in the program body panel below the currently selected command. The **Service panel** displays the point parameters (X, Y, Z coordinates and rotation angles).



*If required, you can verify the point by clicking the “Move to the point” button and adjust the point parameters as required. For adjustments, change the values in the parameter fields of the Service panel.*

- To add the **Open gripper** or **Close gripper** command:

**Step 1.** Press either the **Open gripper** or the **Close gripper** button on the elbow fitting. A corresponding command appears in the program body below the currently selected line.

**Step 2.** Drag-and-drop the command, locating it in the program body below the point where you want the gripper to close/ open.

### 5.1.3 Adding a comment to a program

You may need to add one or more comments to a program to divide its body into subsections or to provide a more detailed description.

To do this, proceed as described below:

1. Select a line within the program body where you want to place a comment.
2. On the **Edit** screen, click  to open the **Add Commands** menu and click **Comment**. The **Commentary** line appears in the program body below the selected command (or you can drag-and-drop it to the top as shown in **Figure 5-4**).

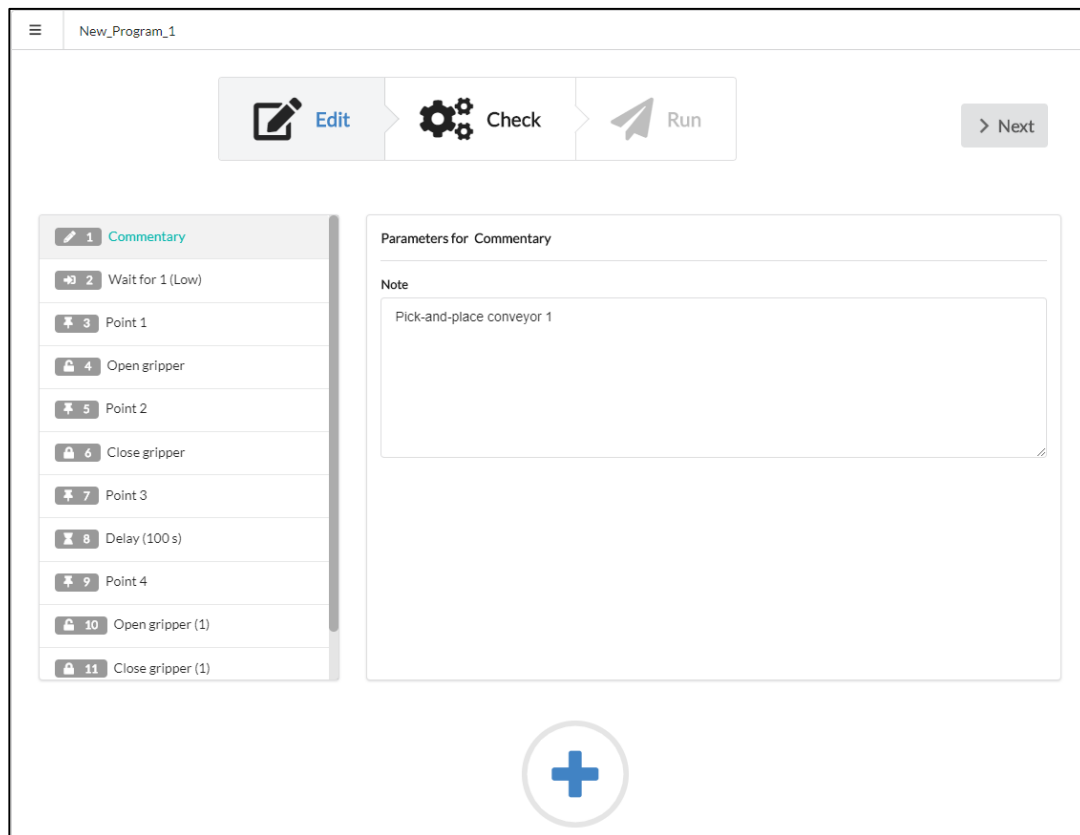

Figure 5-4: Adding a comment to a program

3. In the **Note** field in the **Service panel**, type in the contents of the commentary. The program saves it in the field and, subsequently, displays it every time you select the **Commentary** line in the program body.

### 5.1.4 Setting command parameters

You can set and adjust command parameters **only at the Edit stage**. PULSE DESK enables you to set parameters for the following commands:

- Wait for
- Send to
- Point
- Delay



The **Open gripper** and **Close gripper** commands have no parameters to set.

#### 5.1.4.1 Wait for command

1. In the **Program Body**, select the required **Wait for** command line. The **Service panel** displays fields for parameter setting as shown in **Figure 5-5** below.

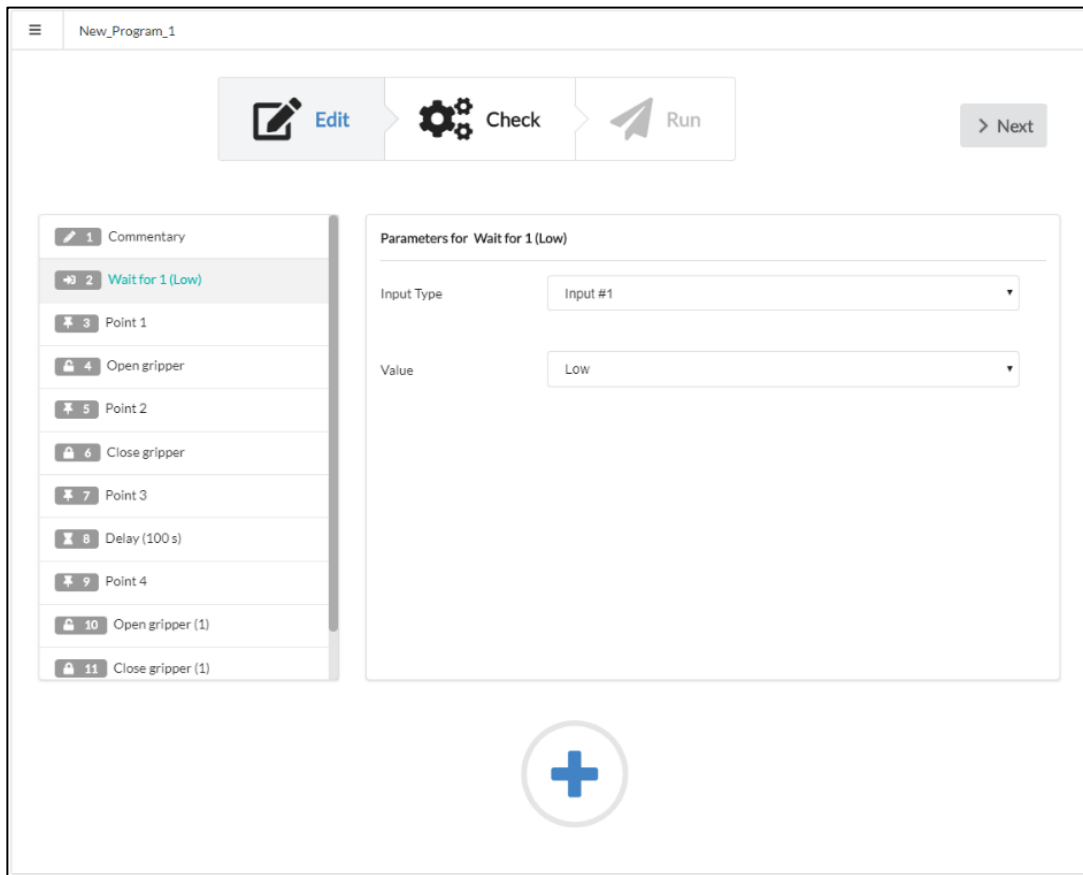

**Figure 5-5: Setting parameters for the “Wait for” command**

2. In the **Input Port** dropdown box, select an input port where the external equipment (e.g., a button) sending an input signal is connected.



An input port is one of the digital inputs on the back panel of the control box.

3. In the **Value dropdown box**, select either **High** or **Low** to specify the type of the signal received by the arm from the external equipment.

**High** = contact closed/ equipment on

**Low** = contact open/ equipment off

#### 5.1.4.2 Send to command

1. In the **Program Body**, select the required **Send to** command line. The **Service panel** displays fields for parameter setting as shown in **Figure 5-6** below.

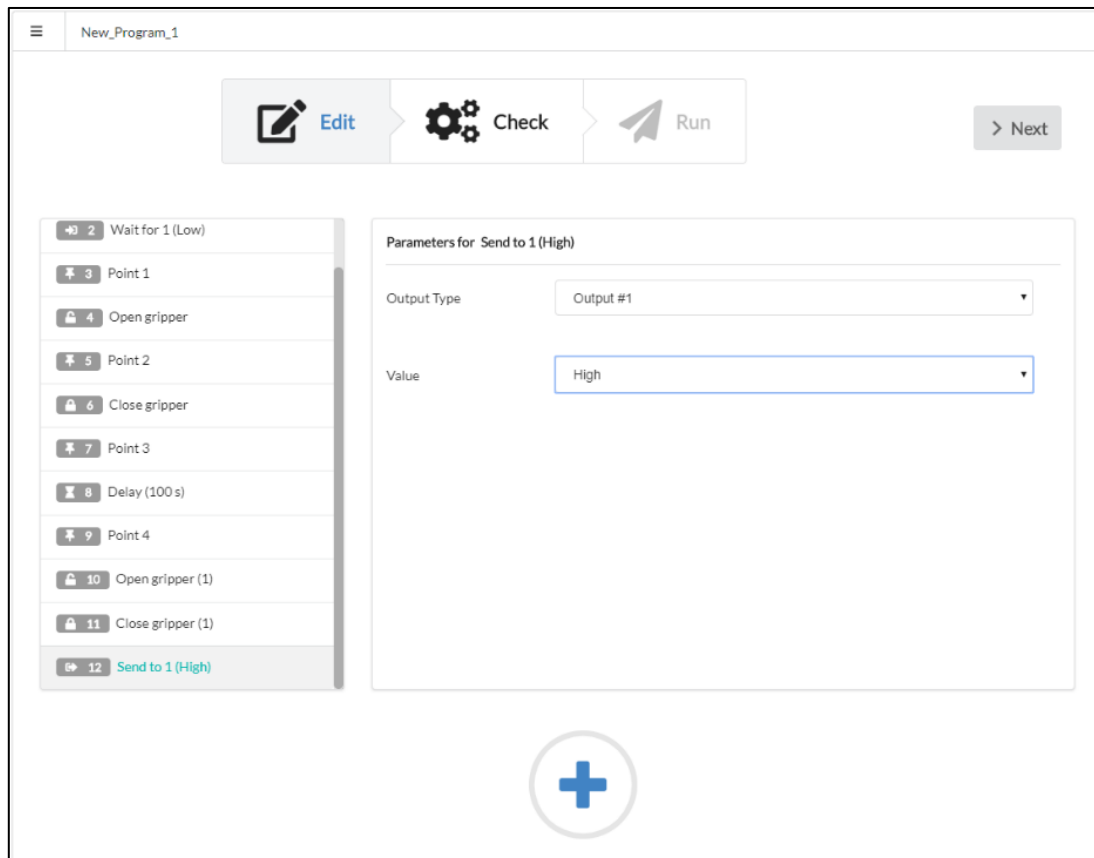

Figure 5-6: Setting parameters for the “Send to” command

2. In the **Output Port dropdown box**, select an output port where the external equipment (e.g., a conveyor belt) receiving an output signal from the arm is connected.



*An output port is one of the digital outputs on the back panel of the control box.*



3. In the **Value dropdown box**, select the output signal type—**High** or **Low**.  
**High** = contact closed/ switch on  
**Low** = contact open/ switch off

### 5.1.4.3 Delay command

1. In the **Program Body**, select the required **Delay** command line. The **Service panel** displays the field for parameter setting as shown in **Figure 5-7**.

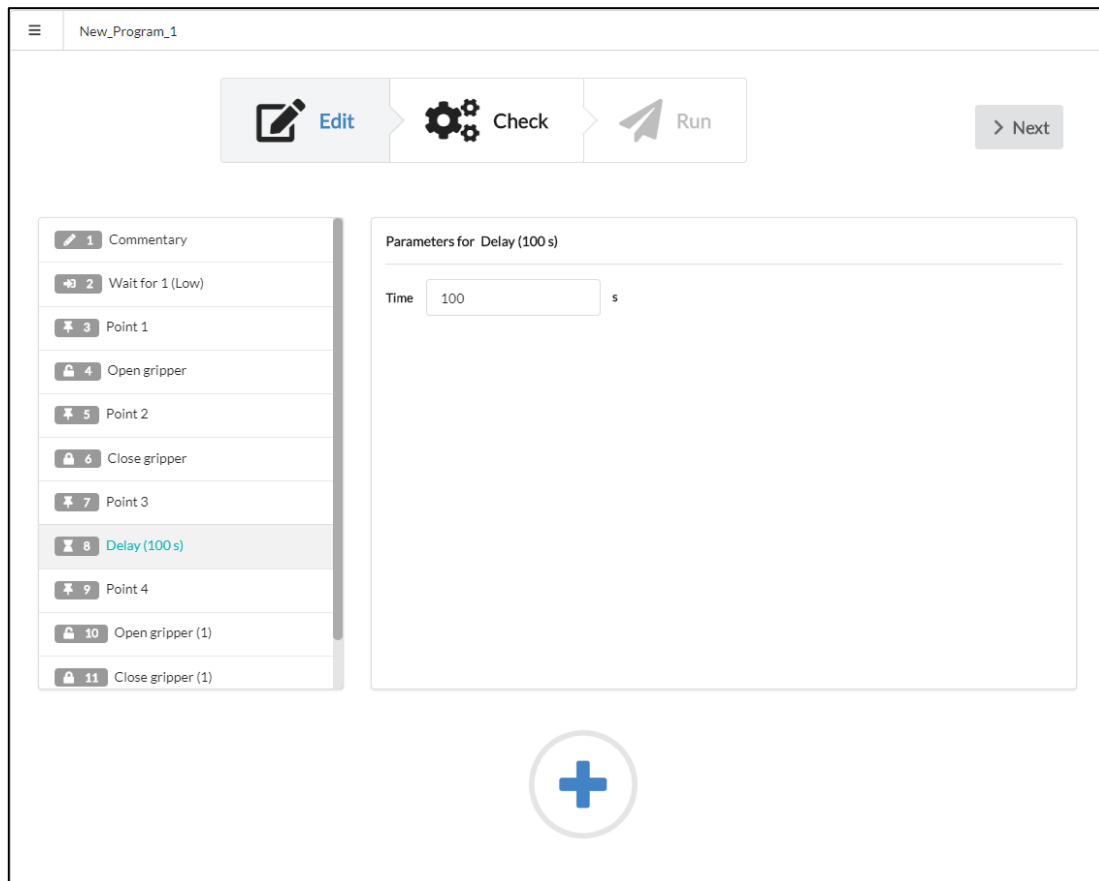

Figure 5-7: Setting the parameters for the Delay command

2. In the **Time field**, specify how long (s) PULSE DESK should wait before moving on to the command following the **Delay** one.



*The default value displayed in the field is 100 s. You can adjust the default setting by simply specifying another value.*

### 5.1.4.4 Point command

1. In the **Program Body**, select the required **Point** command line.
2. In the **Service panel**, type in the coordinates and rotation angles (roll, pitch, and yaw) in the parameter fields or adjust the ones preset in the **Free Drive** mode.

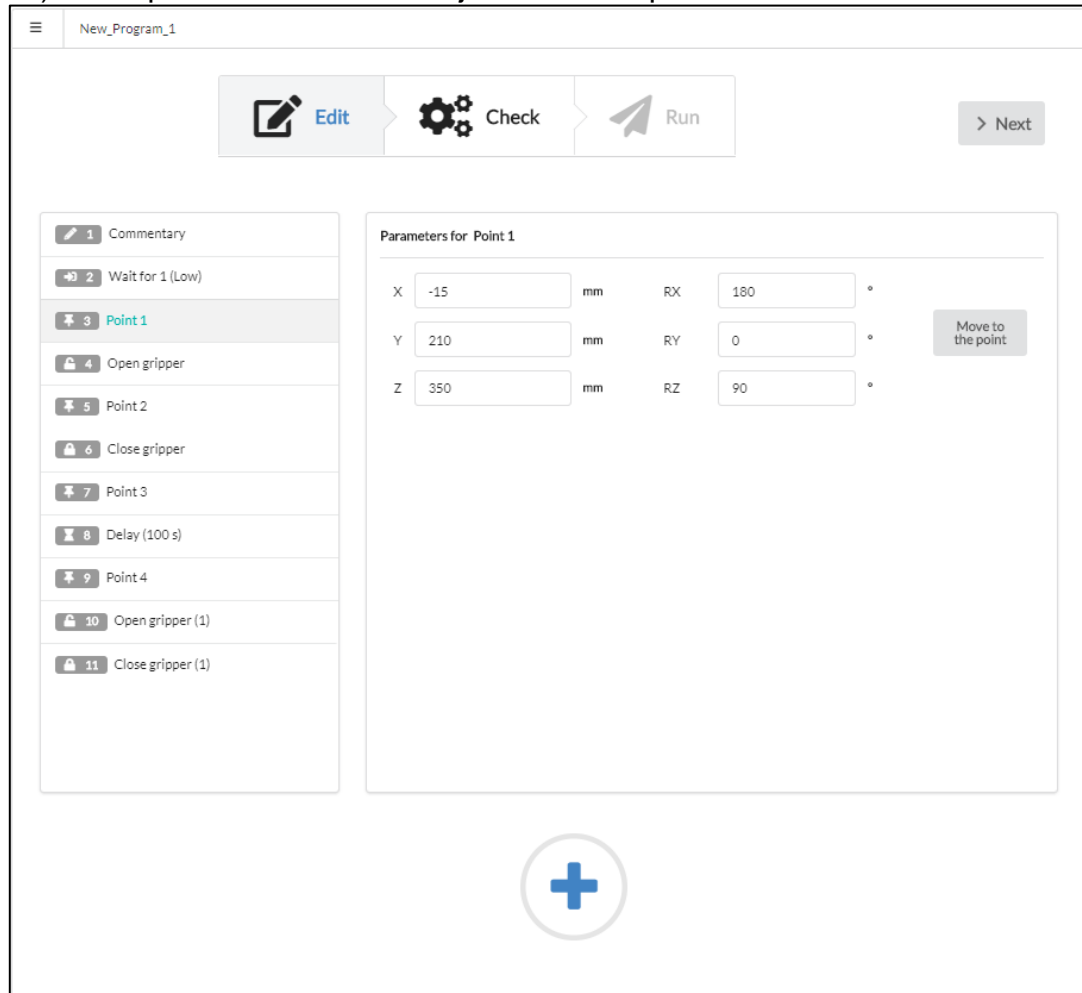

Figure 5-8: Setting parameters for the Point command

As you set the parameters, PULSE DESK prompts you about their admissible ranges as shown in **Figure 5-9**.

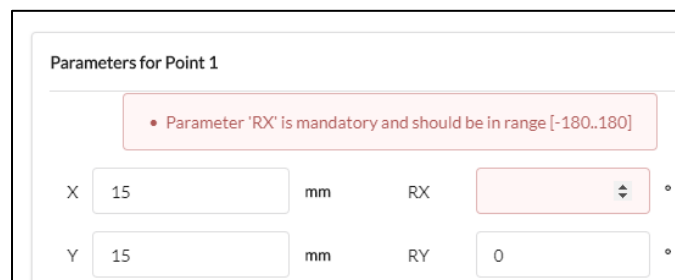

Figure 5-9: Prompt to set point parameters

The coordinates and angles specify the position of the arm's tool center point at the particular point:

X = TCP offset along the axis X relative to the center point in the arm base

Y = TCP offset along the axis Y relative to the center point in the arm base

Z = TCP offset along the axis Z relative to the center point in the arm base



*Physical location of the TCP is at the center of the arm wrist.*

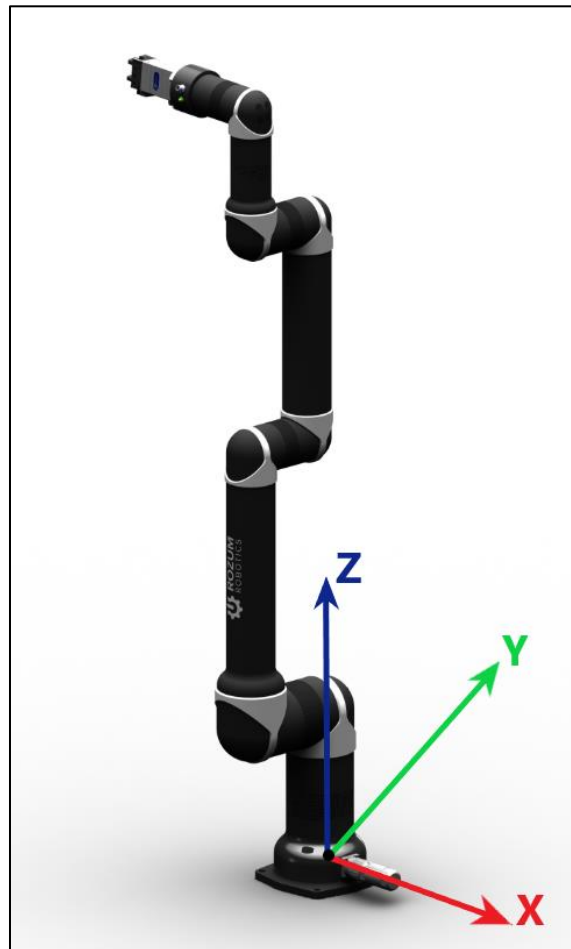

Figure 5-10: The coordinate system

RX = pitch (TCP rotation angle around the axis X)

RY = yaw (TCP rotation angle around the axis Y)

RZ = roll (TCP rotation angle around the axis Z)

3. Verify the resulting arm pose by clicking **Move to the point** in the **Service panel**.

4. If needed, adjust the X, Y, Z coordinates and rotation angles by changing the values in the parameter fields on the **Service panel**.

### 5.1.5 Deleting commands

To remove a command from the **Program Body**, follow the instructions below:

1. Select a command in the **Program Body**.
2. Drag-and-drop the selected command outside the **Program Body** panel. PULSE DESK removes them permanently from the program body.

### 5.1.6 Relocating commands

To relocate a command within the **Program Body**, proceed as follows:

1. Select a command.
2. Drag the selected command to any desired location within the **Program Body**. PULSE DESK displays the command line at the desired location.

### 5.1.7 Renaming commands

To give a command a new name, follow the instructions below:

1. Select the command you want to rename.
2. Click on the command name in the **Service panel** and type in a new name to replace the previous one.

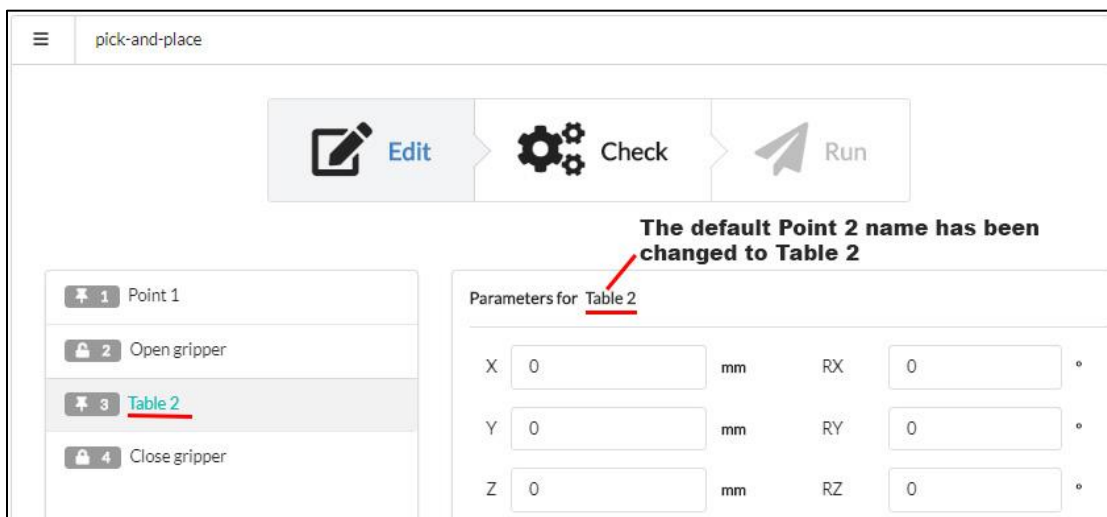

Figure 5-11: Renaming a command

## 5.2 Debugging a program

### 5.2.1 The Check stage screen

Once you have created a program, your next step is to check whether it can work properly with the robotic arm. For the purpose, you need to switch to the **Check** stage and conduct a test run of the program.

To switch to the **Check** stage, click **Next** or the stage name in the **Stepper** on the **Edit** screen. In the **Stepper**, PULSE DESK checks the **Edit** stage indication and moves selection to the **Check** stage. The Check stage screen has the appearance as shown in **Figure 5-12**.

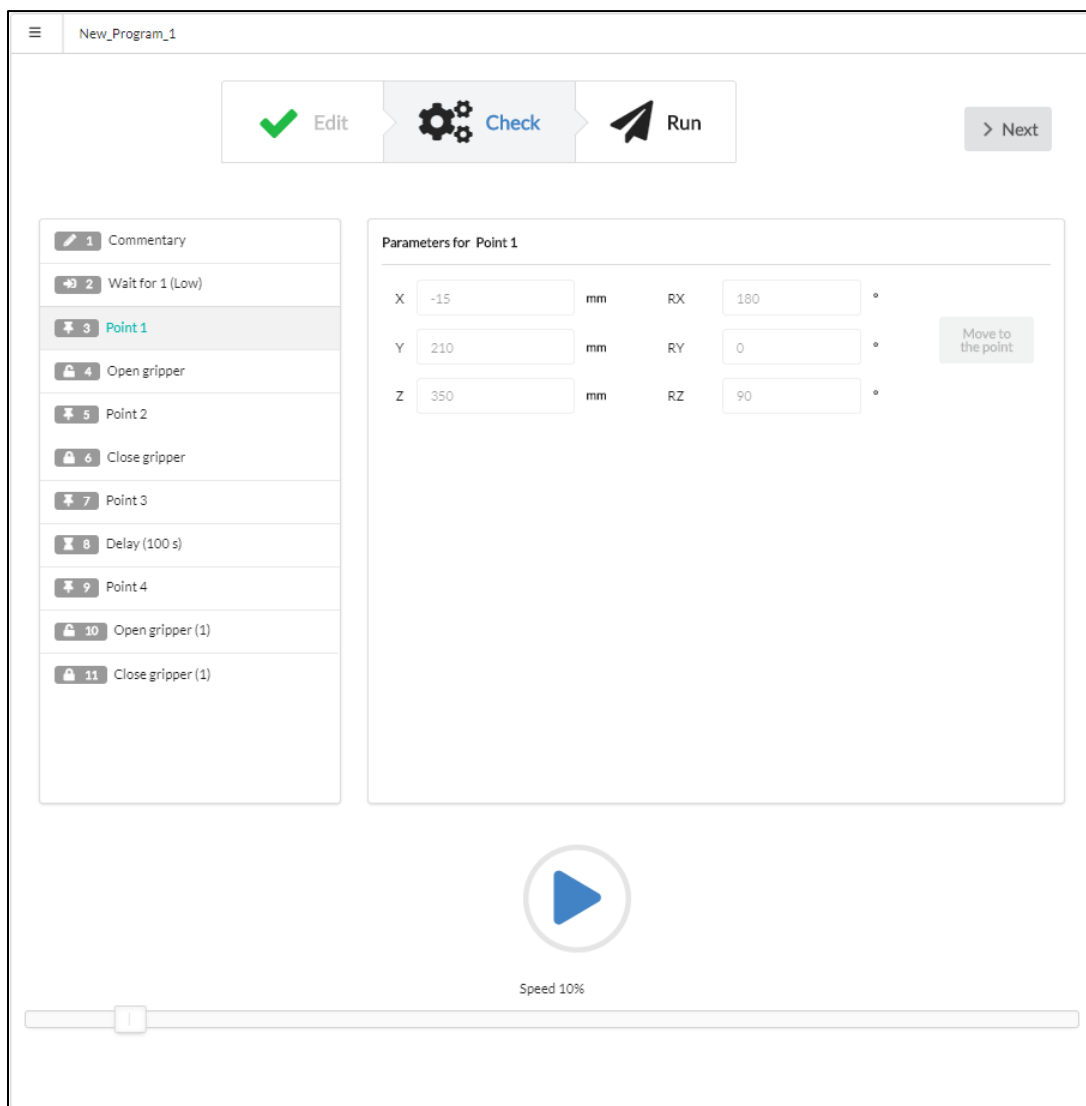

Figure 5-12: The Check stage screen

The **Add Commands button** is not available at the **Check stage**, and you cannot add commands in any other way.







The **Program Body** panel contains the program created at the **Edit stage**. The **Service** panel shows the parameters of the command selected in the Program Body. However, the parameters are not available for editing (greyed out).



*To edit parameters, you need to switch back to the Edit stage. To do this, click Edit in the Stepper.*



**Table 5-1** contains a detailed description of the controls on the **Check stage** screen.



**Table 5-1: The controls on the Check stage screen**

Control	Purpose
 <b>Run</b>	<p>When you click the button, PULSE DESK starts executing the program in the <b>Program Body</b> panel, moving sequentially from one command to another until it reaches the last one.</p> <p>Once PULSE DESK starts a test run,  changes to . Use  to pause/stop execution of the program.</p> <p>When the software executes the <b>Delay</b> and <b>Wait for</b> commands, the additional <b>Step Forward button</b>  appears on the screen next to the <b>Run</b> one. The <b>Step Forward button</b> allows you to skip the current command and move on to execute the immediately following one.</p>
 <b>Speed</b>	<p>The slider element enables adjusting the motion speed of the arm (% maximum speed). The default value is 10%. You can change it by dragging the slider to the right to accelerate the arm motion or to the left to slow the arm down.</p>

## 5.2.2 Conducting a test run

To start a test run of the program displayed in the **Program Body**, click . The robotic arm system and the PULSE DESK software react as described below:

1. The system goes to the **WORK** state, changing its LED indication accordingly (see **Table 1-14**). Simultaneously,  changes to .
2. PULSE DESK begins to execute the commands in the **Program Body**—from the first one on the list down to the last one.

3. As the software goes from one command to another, the selection frame moves down the **Program Body**. The **Service panel** displays the parameters of the currently selected command.
4. After PULSE DESK executes the last command in the **Program Body**, it stops the test run and displays an appropriate message. The button  changes to . The system goes to the READY state.

## 5.3 Running a program

Once you have checked and debugged a program, you can proceed to execute it at the next stage—**Run**. To switch to the **Run stage** from the **Check** one, click **Next** or the stage name in the **Stepper**.

When PULSE DESK switches to the **Run stage** screen (**Figure 5-13**), it checks the **Check** indication in the **Stepper**, moving selection to the **Run** one.

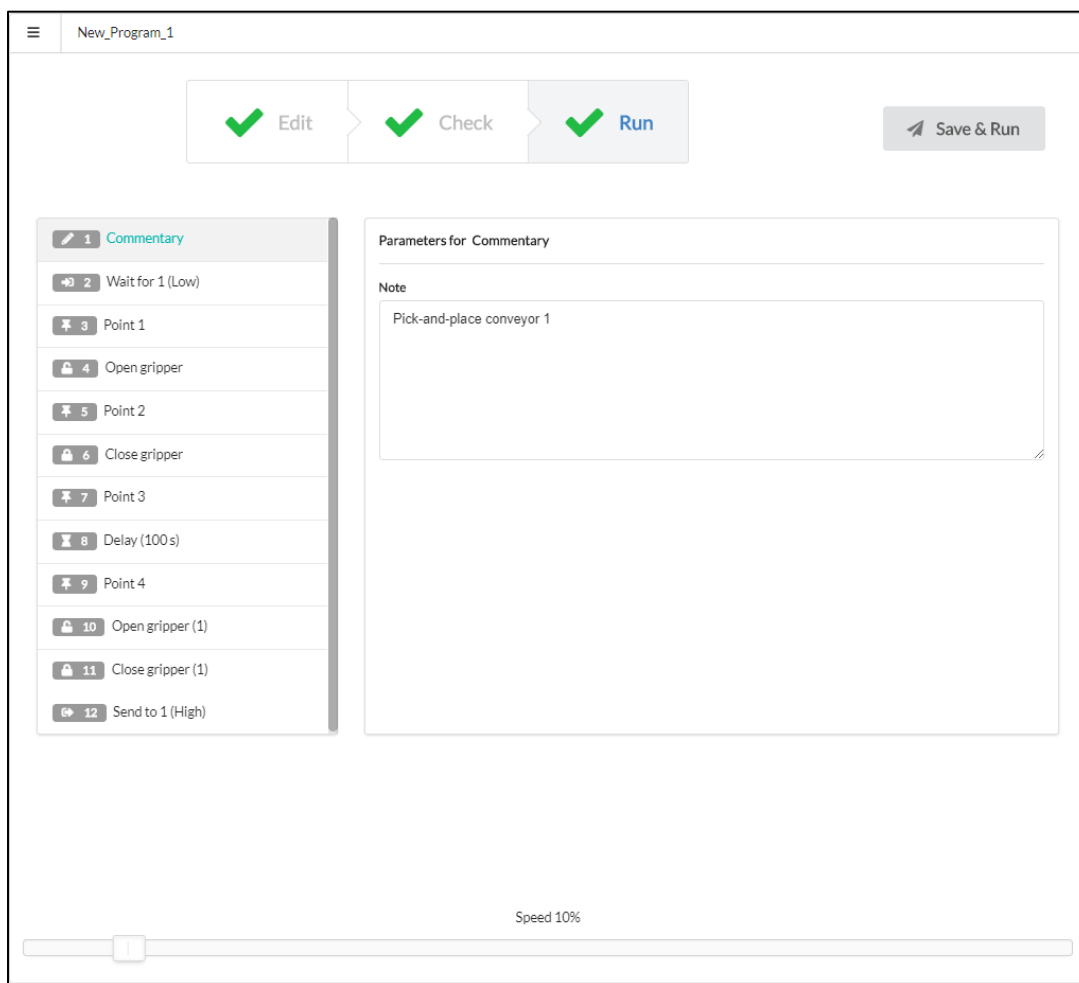

Figure 5-13: The Run stage screen

### 5.3.1 Program execution

To start execution of your program, click **Save&Run**. PULSE DESK saves changes to the program (if any) and starts executing the commands in the **Program Body**—from the first one down to the last one. Simultaneously, **Save&Run** changes to **Stop**.

You can monitor the execution progress by following the way selection in the **Program Body** moves down the command sequence. Execution results are saved to a production log (available to service personnel only).

As PULSE DESK reaches the last command in the **Program Body**, it starts running the same program anew and keeps repeating it cyclically until the user stops its execution (see **Section 5.3.2**).

### 5.3.2 Stopping a program

To stop a running program, click  on the **Run stage** screen. After clicking, the **Stop button** changes to the **Save&Run** one.

In addition, PULSE DESK requests to stop program execution when the user selects **Load program** or **New program** on the **Main Menu** (see **Section 4.3**). As the request appears on the screen, click **Yes** to stop the program or **No** to continue its execution.

#### 5.3.2.1 Emergency stop

When the user stops the system by pressing the emergency stop button (see **Figure 5-14**):

- The system performs a Category 1 Stop.
- PULSE DESK disables the user interface elements and shows a splash screen warning that the system is in the emergency state.



Figure 5-14: The emergency stop button



To resume operation of the robotic arm after an emergency shutdown, reset the system as described below:

1. Wait for the arm to come to a full stop. The wrist LED on the arm should go off.
2. Unpress the emergency stop button.
3. Flip the power switch on the back panel of the control box to the off position or unplug the power cord from the mains socket. Wait for the LEDs on the control box to go off completely.
4. Switch the robot on again as described in **Section 3.1**.



**Before restarting the system after an emergency shutdown, make sure the emergency stop button is unpressed. Otherwise, the system will not start, causing the red LED on the control box to light up.**

### 5.3.3 Saving a program

To save a program, follow the sequence of actions as below:

1. Open the **Main menu** and select **Save program as**.
2. In the displayed dialogue box (**Figure 5-15**), specify a name for the program and confirm the input by clicking **Yes**.

Save changes

Save this program as

Pick-and-place

No Yes

Figure 5-15: “Save program as” dialog box

PULSE DESK saves programs automatically when you click the **Save&Run** button at the **Run** stage.

### 5.3.4 Renaming a program

To change a program name, follow the instructions below:

1. Open the **Main menu** and select **Save program as**.
2. In the displayed dialogue box (**Figure 5-15**), specify a new name for the program and confirm the changes by clicking **Yes**.



*It is also possible to rename the program by changing its name in the Program Name field. However, to save the changes, you need to call the Save program as dialog.*

---

## 5.4 Managing programs

PULSE DESK offers the following capabilities for managing programs:

- loading a created program into the **Program Body** panel
- deleting a created program

### 5.4.1 Loading a program

Instead of creating a new program, you can reuse any of the previously created ones. To do this, follow the instructions below:

1. Click the **Main menu button** to open the **Main menu**.
2. In the sub-menu below the **Load program** command, select the program you need. PULSE DESK loads the content of the selected program into the **Program Body** panel.



*If there is a program already running when you attempt to load another one, PULSE DESK requests to stop it. You need to confirm stopping the currently executed program by clicking **Yes**.*

### 5.4.2 Deleting a program

To delete a program, follow the instructions below:

1. Load the program you want to delete into the **Program Body** as described in **Section 5.4.1**.



*If the program is already displayed in the Program Body, move on to Step 2.*

2. Open the **Main menu** and select **Delete program**. PULSE DESK removes the program contents from the **Program Body** and deletes the program name from the **Load program** sub-menu.

## 5.5 Closing PULSE DESK

To quit PULSE DESK, the user needs to carry out the following actions:

1. Stop the currently running program (see **Section 5.3.2**).
2. Close the browser page.

The software stops execution of the program. The system goes to the READY state (Freeze mode). The control buttons are disabled.



*If you quit PULSE DESK without stopping the currently running program, the software keeps executing the program cyclically even after you close the browser page.*

## 5.6 Updating PULSE DESK

Two methods are available to update the PULSE DESK software to the newest version:

- direct updating via Internet
- updating from a USB



***During updates, no power is supplied to the arm, so the motors in its joints cannot hold their positions. Therefore, prior to updating, put the arm in a safe position — the way you keep it when the control box is off.***

### 5.6.1 Direct updating via Internet

If the local network comprising a PULSE robot has an active Internet connection, users get popup notifications about available updates (if any) during PULSE DESK initialization.

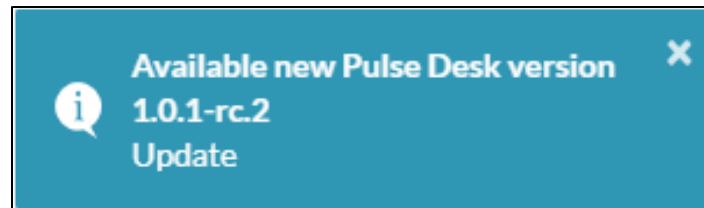

Figure 5-16: Update notification

To update PULSE DESK via Internet:

1. Click the notification (**Figure 5-16**).
2. Confirm the update by clicking **Yes** in the displayed dialog. PULSE DESK installs the update automatically. Mind that the entire updating process can take **up to 15 minutes**.

While updating is under way, access to the PULSE DESK user interface is disabled, whereas the LED on the arm wrist is always off. In the normal course of updating, you will also see the control box switching off and rebooting several times, its red LED lighting up, or its LEDs going off completely.



***Never reboot or switch off the control box during an update manually whatever behavior it demonstrates (no LEDs on, no sound of operation, etc.). If you have any doubts, contact the Technical Service.***

3. Once updating is over, the control box reboots automatically and then the arm restarts in the normal way (see **Table 1-14**). Wait for the green LED on the control box to light up and go steady and the wrist LED to go steady green. Then, refresh the browser page with the PULSE DESK screen.
4. Make sure the software has been updated as appropriate. To do this, specify *IP address+port number/api/update/version* in the browser line and check the product release version in the response.



***If the update failed, contact the Service personnel for assistance and continue using the older version.***

## 5.6.2 Updating from a USB

Use the method to update PULSE DESK, when your PULSE robot has no access to Internet. The updating sequence is as follows:

1. Download the latest version of the software to your USB, saving it in the main directory.
2. Switch the arm in accordance with **Section 3.1**. Wait until the initialization procedure is completed and the arm is in the READY state. The green LED on the control box should be constantly on, and the wrist LED should be steady green.
3. Insert the USB into the appropriate port on the back panel of the control box.



4. Start PULSE DESK as described in **Section 4.1** and wait for about 10 seconds. During the time, the arm compares the current PULSE DESK version with that saved on the USB. If the software version on the USB is higher than the currently used one, PULSE DESK displays an update notification (see **Figure 5-16**).
5. Click the notification.
5. Confirm the update by clicking **Yes** in the displayed dialog. PULSE DESK installs the update automatically. Mind that the entire updating process can take **up to 15 minutes**.

While updating is under way, access to the PULSE DESK user interface is disabled, whereas the LED on the arm wrist is always off. In the normal course of updating, you will also see the control box switching off and rebooting several times, its red LED lighting up, or its LEDs going off completely.

**⚠ Never reboot or switch off the control box during an update manually whatever behavior it demonstrates (no LEDs on, no sound of operation, etc.). If you have any doubts, contact the Technical Service.**

6. Once updating is over, the arm resets automatically and then restarts in the normal way (see **Table 1-14**). Wait for the green LED on the control box to light up and go steady and the wrist LED to go steady green. Then, refresh the browser page with the PULSE DESK screen.
7. Make sure the software has been updated as appropriate. To do this, specify *IP address+port number/api/update/version* in the browser line and check the product release version in the response.



*If the update failed, contact the Service personnel for assistance and continue using the older version.*

## 6 CONTROLLING THE ARM VIA REST API

Apart from programming via the PULSE DESK user interface, users can control the PULSE arm via the REST Application Programming Interface (REST API).

### 6.1 Enabling API access

By default, access to the REST API is disabled. To enable access to the API functionality proceed via PULSE DESK as below:

1. Start PULSE DESK in accordance with the instructions in **Section 4.1**.
2. Click the **Main Menu** button and select **Configure**. PULSE DESK opens the **Configure screen** as shown in **Figure 6-1**.

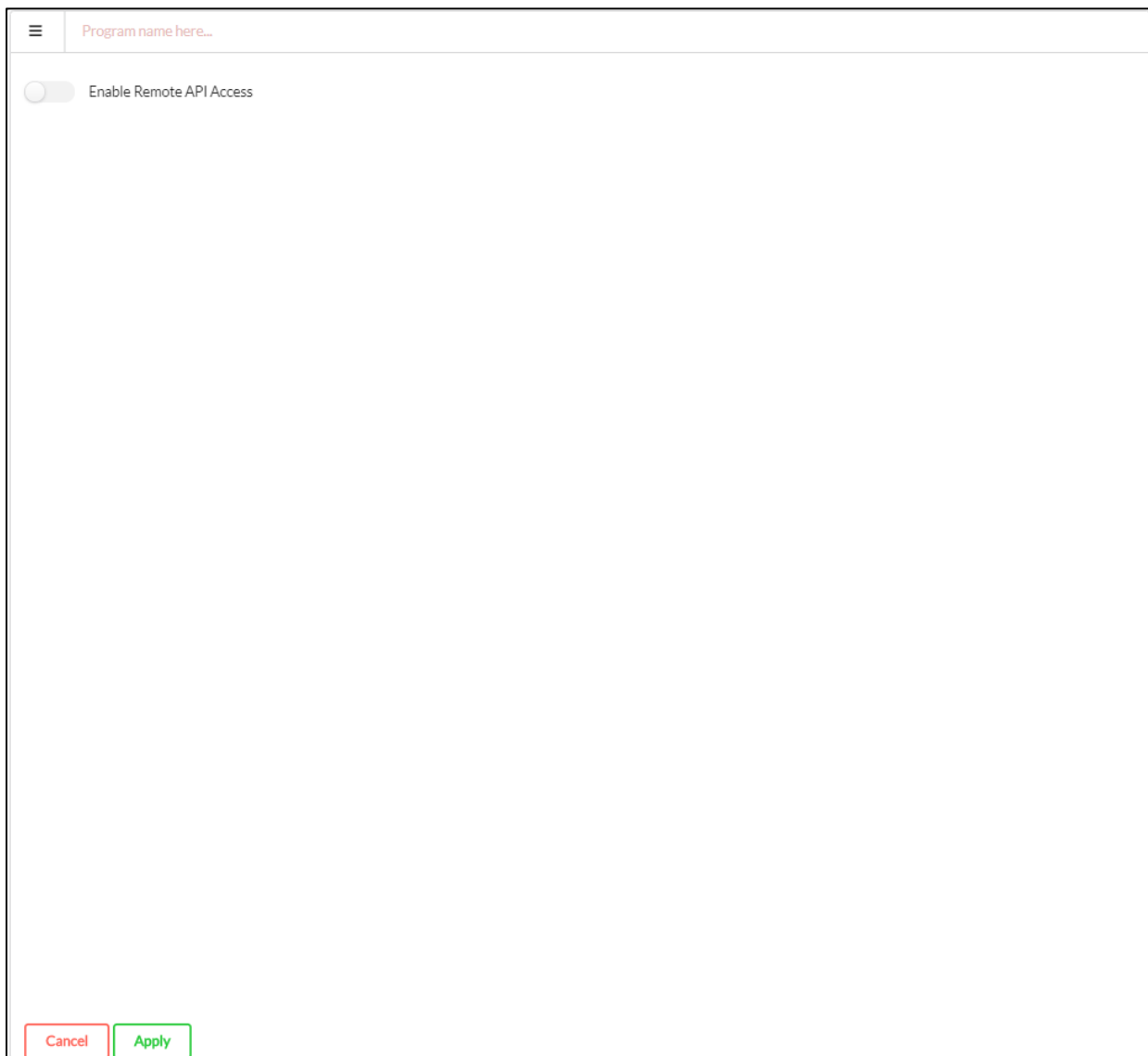

**Figure 6-1: Configure screen (with the API toggle in the disabled state)**

- On the displayed screen, switch the **Enable Remote API access** toggle to the enabled state.



- To confirm, click the **Apply** button (located in the bottom of the screen).

Now, you can start sending API requests and processing API responses. For detailed information on available commands and their use, refer to the document “[REST API Reference Guide](#).”



*In addition, you can use Python implementation of the REST API methods. The Python API library and detailed data are available at <https://github.com/rozum-robotics/pulse-api>.*

Once you enable remote API access, programming via PULSE DESK becomes impossible. If you try access the user interface (UI) functionality, the screen displays the message as shown below.



To access the UI functionality, you need to disable API access (see **Section 6.2**).

## 6.2 Disabling API Access

To disable API access, follow the instructions below:

- Click the **Main Menu** button and select **Configure**.
- In the displayed **Configure screen** (see **Figure 6-1**), switch the **Enable Remote API access** toggle to the disable state.



- To confirm, click the **Apply** button (located in the bottom of the screen).

## 7 SANDBOX

With regard to the PULSE robotic arm, a **sandbox** is a special virtual environment enabling the following:

- secure execution of custom user programs in a space isolated from the PC module running the PULSE DESK software
- controlling the PULSE robotic arm without using an external control device, such as a notebook, a computer, etc.

The sandbox is initialized automatically in the course of the control box initialization and is immediately available for use as soon as the initialization is over. However, it is completely isolated from the control box resources and files.

### Operating the sandbox

To be able to run and manage custom programs in the sandbox, you need to enable **SSH access**.

Make sure to use the following connection settings:

- sandbox port: **22**
- control box port: **2222**
- login: **sandbox**
- default password: **sandbox**
- IP address: **DHCP address of the control box** in the user network (see **Section 3.2.2**)



*Subsequently, the user can change the default password to any other value at their discretion.*

Once the SSH access is enabled, you can proceed to run a preloaded program. The robotic arm executes the program in an autonomous mode without interacting either with the control box or with an external control device (e.g., notebook, computer, etc.).

### Loading external software to the sandbox

To load external software to the sandbox, use the **sftp** protocol with the same connection settings as for enabling SSH access.



*For loading operations, enabling **SSH access** is not mandatory.*

The sandbox does not save loaded software automatically. Therefore, in case of a power outage or after you switch off the control box, all of the previously loaded and unsaved programs are cleared from the sandbox. To save a program permanently to the sandbox, you need to use the **Commit** command.

In addition, there is a 500 Mb backup folder where you can manually save any data essential to work with the sandbox (e.g., programs, execution logs). The data in the folder remains intact even when the sandbox is reset to defaults and can be subsequently retrieved at user discretion. The default access path is [home/pulse-desk/share](#).

## 8 SWITCHING OFF THE PULSE ARM

To switch a PULSE robotic arm off, follow the instructions below:

- 1 Set the arm into a safe position where it can remain stable when power supply is disconnected.
- 2 Switch the power switch on the back panel of the control box to the off position. Wait for the front panel indicators to go off.



## ANNEX I. SAMPLE PULSE DESK PROGRAM

Below, we provide a detailed step-by-step instruction describing how to create, check, and execute a simple PULSE DESK program.

**Reference conditions:** The program is intended to perform a pick-and-place operation, moving two nuts from one location to another. For the case, we assume relocating the nuts is from a table to a conveyor belt.

The general recommendation is to observe the following sequence of actions:

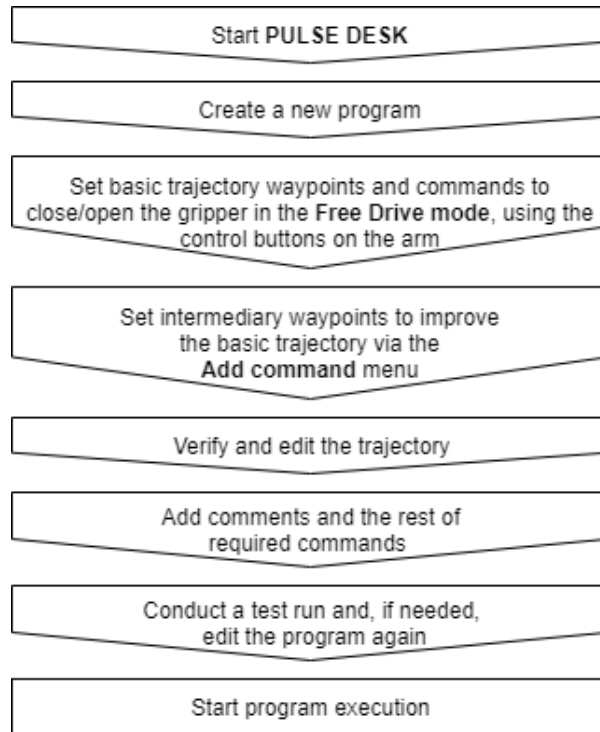

*All parameter values are for reference only. To create a program for your purpose, you should use your own values specific to your application and operating conditions.*

### Starting PULSE DESK

1. Start PULSE DESK by typing in the dynamic or static IP address of the PULSE arm in the local network (for instructions to set IP, see **Section 3.2**) and *the port number (:8080)* in the browser line.

The browser displays either the starting page of the PULSE DESK program, if it is the initial start, or the **Edit stage** screen.



*In case, when you try to access PULSE DESK, the screen displays an emergency message stating that the user interface is unavailable, click the Main Menu button, then select Configure and make sure the Enable API access toggle is in the disabled state (for details, see Section 6).*

## Creating a new program

2. On the displayed screen, click the **Main Menu** button.

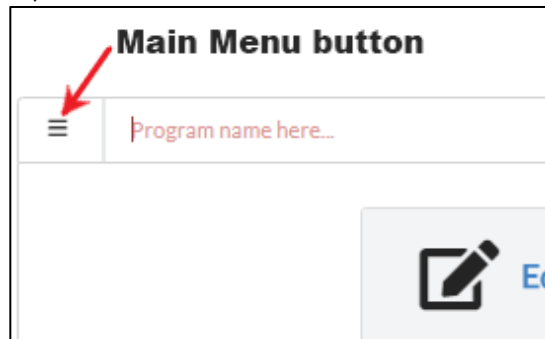

3. On the Main menu, select **New program**. PULSE DESK loads the **Edit stage** screen of the newly created program with the **Wait for** command already in the program body.

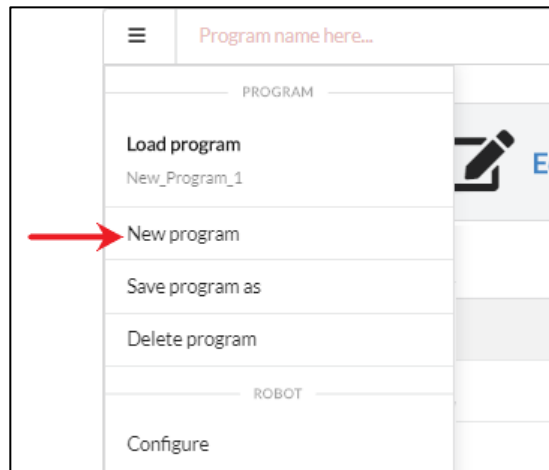

4. On the **Main Menu**, select **Save program as** and type in a name for your program (e.g., *Pick-and-place-nuts*) in the displayed dialog box.

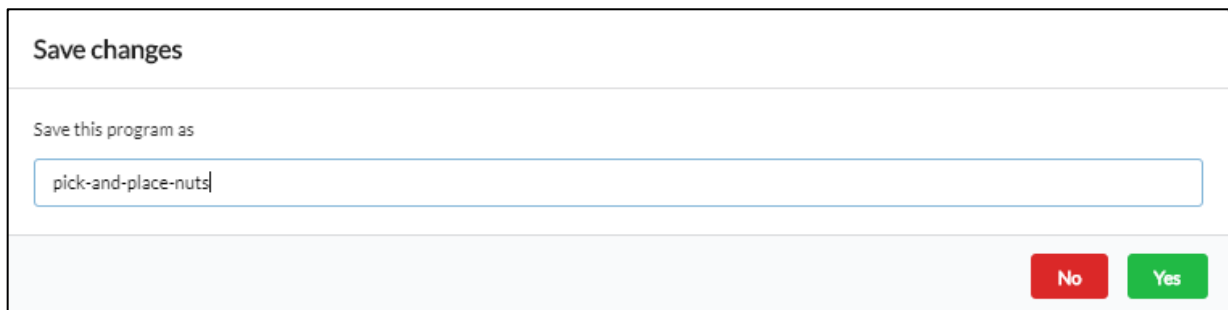
A screenshot of a "Save changes" dialog box. The title is "Save changes". Below the title, it says "Save this program as". There is a text input field containing the text "pick-and-place-nuts". At the bottom right, there are two buttons: a red "No" button and a green "Yes" button.

- Click **Yes** to confirm saving the program under the name and close the dialog box. The specified name appears in the **Program Name** field.

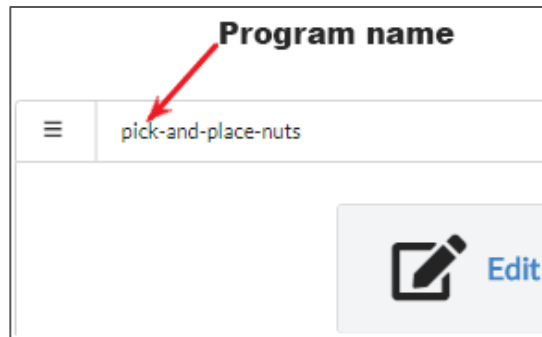

### Setting a basic trajectory by hand guiding

For the particular trajectory, we will set 5 basic waypoints, using the elbow buttons:

- **Point 1**—start position
- **Point 2**—to pick up nut 1
- **Point 3**—to move nut 1 from its original location to a conveyor belt
- **Point 4**—to pick up nut 2
- **Point 5**— to move nut 2 from its original location to the conveyor belt



***The elbow buttons are active in the LEARN mode only. When you switch to the PULSE DESK interface to perform any actions (e.g., to edit a point, add a command via the Commands menu), the mode is off. To switch back into the LEARN mode, you will have to create a new program.***

In addition, we will also add commands to open/close the gripper at respective waypoints.

- Press the **Free Drive** button on the elbow of the robotic arm and start moving the arm joints by hand to set it into the start pose.



***In the Free Drive mode, the arm joints are not locked. Make sure to hold the arm tightly, providing proper support.***

- Once you are in the required start pose, press the **Free Drive** button again. The arm goes to the Freeze mode, which means its joints are locked in their current positions.

- Press the **Point** control button to remember the arm pose as the first waypoint in its trajectory (see Figure below).

The software adds the point to the program body (default name **Point 1**), clearing the **Wait for** command. The **Service panel** displays **Point 1** parameters—the coordinates and rotation angles of the tool center point (TCP) in the position.

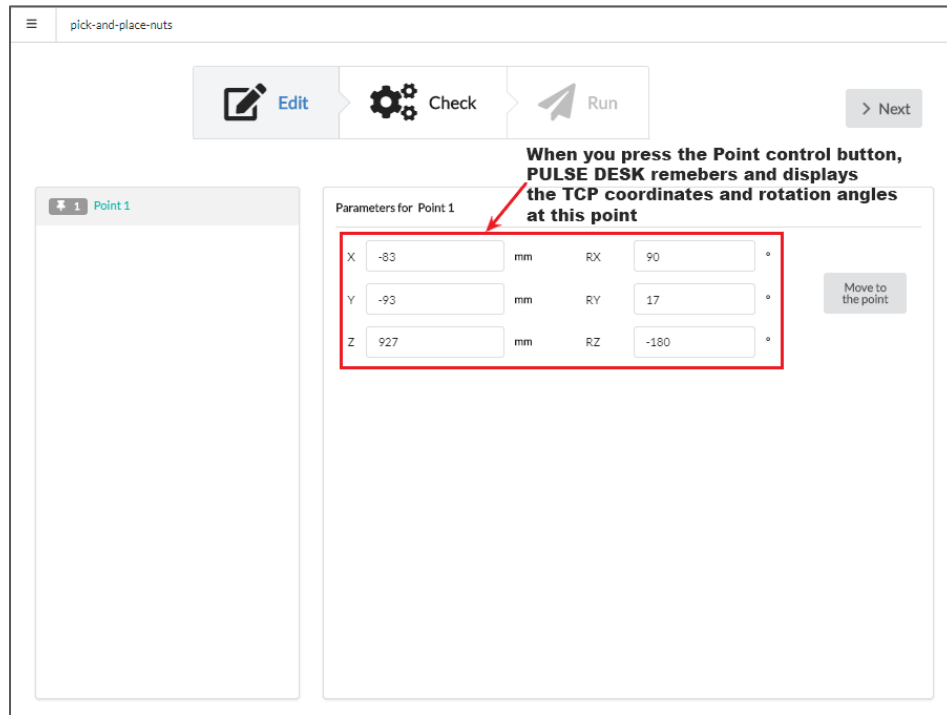

- On the arm elbow, press the **Open gripper** button. The **Open gripper** command appears below **Point 1** in the program body.

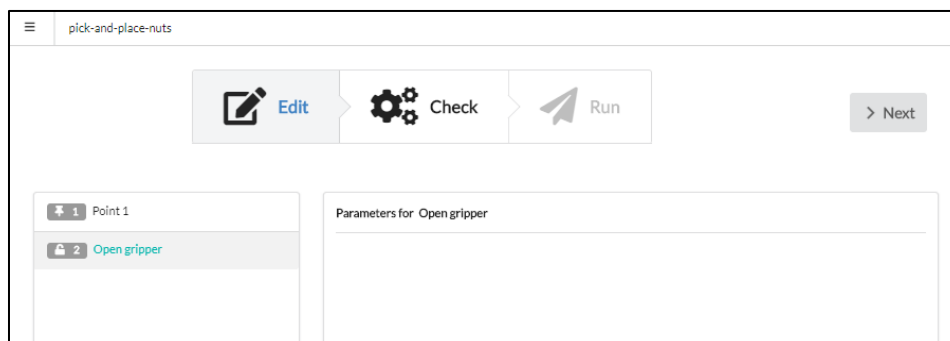

10. Repeat the same actions as described in **Step 6 to 8** to set **Point 2** to pick up nut 1.

A corresponding command line (default name **Point 2**) appears in the program body. On the **Service panel**, you can see the TCP coordinates and rotation angles specifying the arm position at the point.

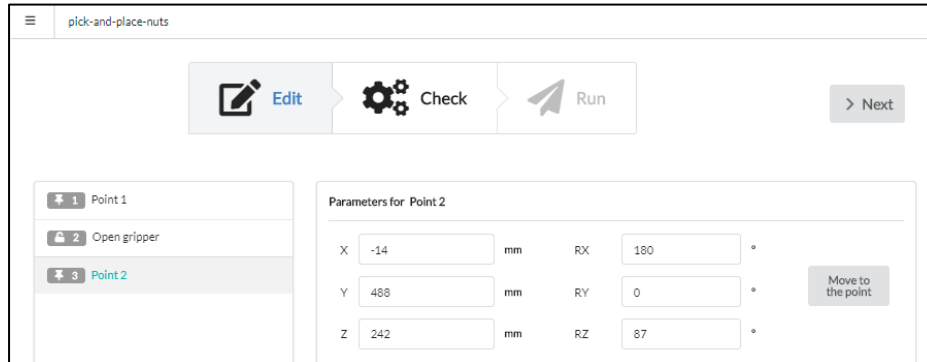

11. To grab nut 1 at **Point 2**, press the **Close gripper** button on the arm elbow. The corresponding command appears below **Point 2** in the program body.

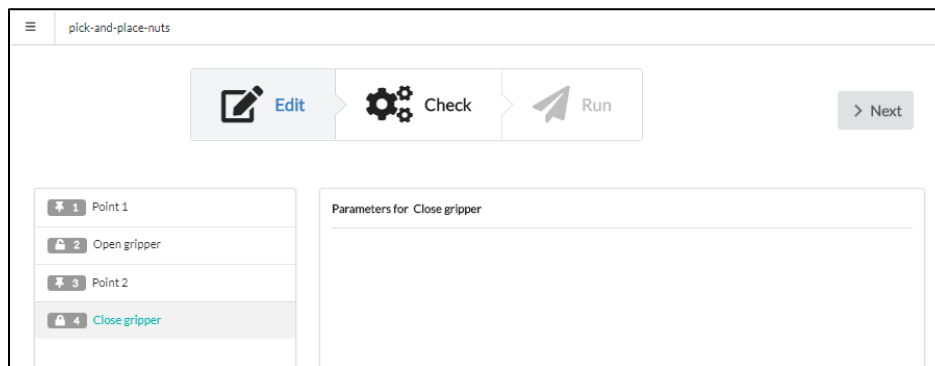

12. Set **Point 3** to move nut 1 from its original location to a conveyor belt. For the purpose, repeat the same actions as described in **Step 6 to 8**.

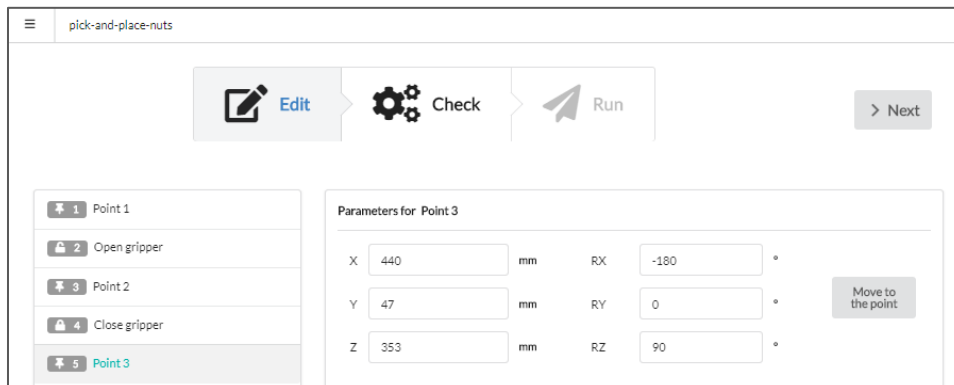

13. To open the gripper and release nut 1 at the new location, press the **Open gripper** button. The **Open gripper (1)** command appears below **Point 3** in the program body.

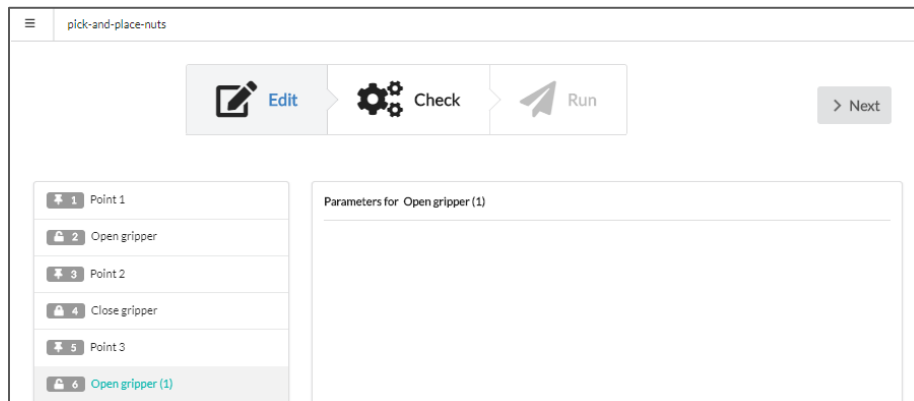

14. Set **Point 4** to pick up nut 2 by following the instructions in **Step 6 to 8**.

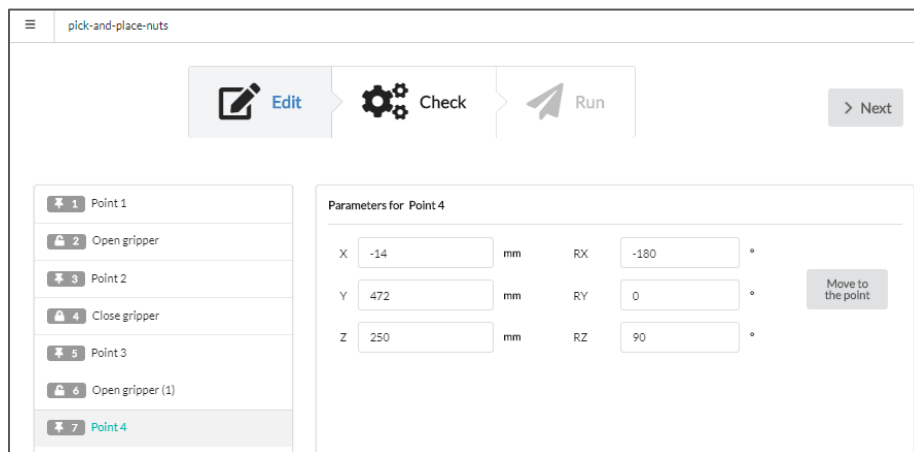

15. To grab nut 2 at **Point 4**, press the **Close gripper** button on the arm elbow. The **Close gripper (1)** command appears below **Point 4** in the program body.

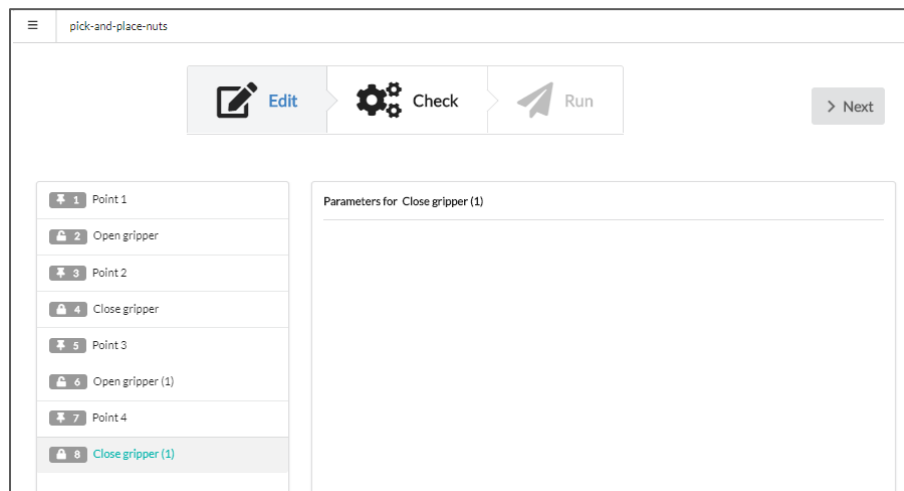

16. Set **Point 5** to move nut 2 from its original location onto a conveyor belt, following the instructions in **Step 6 to 8**.

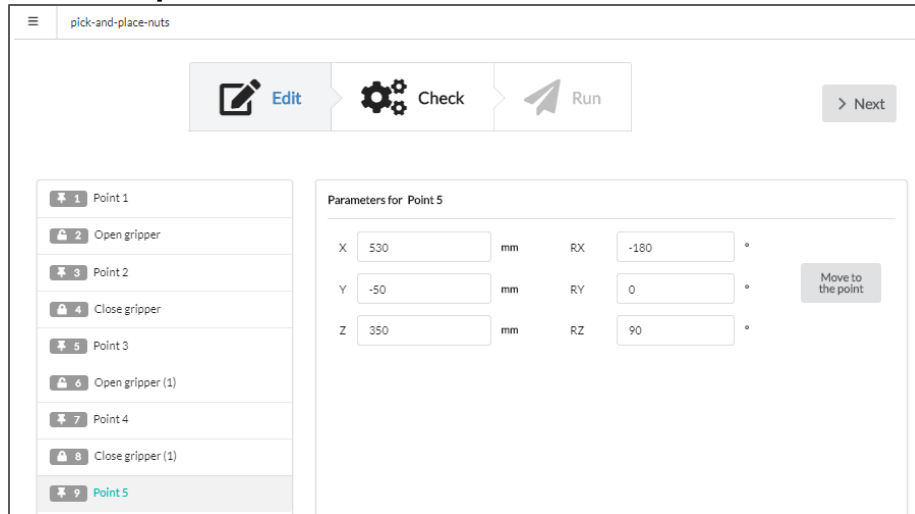

Now, you can quit the LEARN mode and start working with **Add commands menu**. Your next task is to add intermediary points to make the arm trajectory smoother.

### Setting intermediary waypoints

In this particular case, we set up **two intermediary waypoints** for each of the already preset point in the basic trajectory—**Point 1 to Point 5**. One of the intermediary waypoints is to approach a preset point before lowering the gripper and the other—to lift the gripper before moving on to another waypoint.

17. Add an intermediary waypoint to approach **Point 2**. To do this, select the command preceding the point in the program body. Click **+** and select **Point**.

A new command line (default name **Point 6**) appears in the program body preceding **Point 2**. The parameter fields on the **Service panel** contain default zeros.

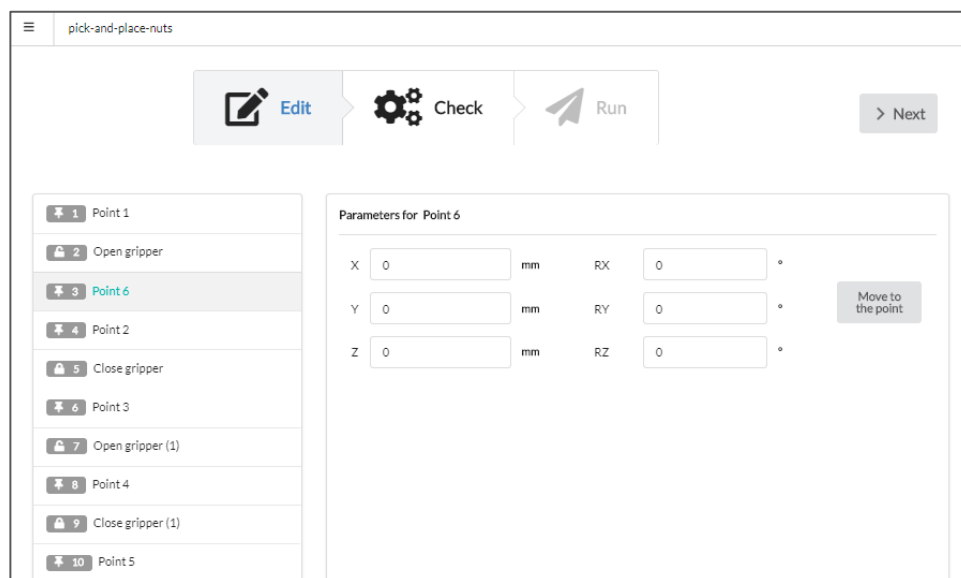

18. In the parameter fields on the **Service panel** for **Point 6**, type in the same coordinates and rotation angles as for **Point 2**. The only change you need to make is to adjust the Z coordinate to a higher value so that the gripper at **Point 6** would be slightly above **Point 2**.

Parameters for Point 2					
X	-14	mm	RX	180	°
Y	475	mm	RY	0	°
Z	240	mm	RZ	90	°
Parameters for Point 6					
X	-14	mm	RX	180	°
Y	475	mm	RY	0	°
Z	260	mm	RZ	90	°

The parameter values for the two points should be identical, except for the Z coordinate

19. Set up an intermediary waypoint to lift the gripper at Point 2. To do this, select **Close gripper** in the program body and click **+**. In the displayed menu, select **Point**.

A new command line (default name **Point 7**) appears in the program body below **Close gripper**. The parameter fields on the **Service panel** for **Point 7** contain default zeros.

20. In the parameter fields on the **Service panel**, specify the same coordinates and rotation angles as for **Point 6**.

Parameters for Point 7					
X	-14	mm	RX	180	°
Y	475	mm	RY	0	°
Z	260	mm	RZ	90	°

21. To set intermediary waypoints to approach **Point 3**, **Point 4**, and **Point 5**, repeat the same actions as in **Step 17** and **Step 18**. To specify the waypoint parameters use the same values as for the basic points, making sure to change the Z coordinate to a higher value.
22. To set intermediary waypoints to lift the gripper at **Point 3**, **Point 4**, and **Point 5**, repeat the same actions as in **Step 19** and **Step 20**. Make sure that the parameters of the intermediary points are identical to the ones preset for the waypoints in **Step 21**.



23. Set up the end pose. To do this, click  and choose **Point**. In the parameter fields on the **Service panel**, set up the same coordinates and rotation angles as for the start position.

 After completing the actions as described above, we get a motion trajectory comprising the total of 15 points.

### Verifying and editing the trajectory

24. To verify **Point 1**, select the point in the program body. On the **Service panel**, click the **Move to the point** button to see how the arm moves to the specified position.
25. Adjust the coordinates and rotation angles on the **Service panel**, changing manually the values in the parameter fields.
26. Repeat the same actions as described in **Step 24 to 25** to verify and adjust the rest of the points in the program body.

 The **Open gripper** and **Close gripper** command have no parameters to edit.

### Adding a comment and setting other commands

27. Click  and select **Comment**. PULSE DESK adds the **Commentary** line to the program body below the currently selected command.
28. Drag the command line to the top (as shown in the figure below). In the **Note** field on the **Service panel**, type in any detailed description of the program as required.

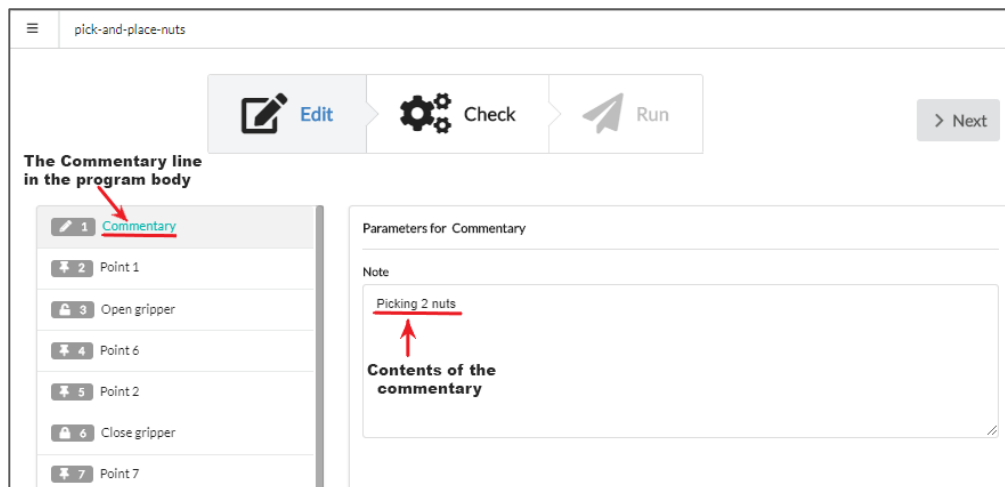

29. Select **Commentary** in the program body and click , then select **Wait for**. The command appears in the program body, and the **Service panel** displays the fields to set up the command parameters.

30. To set up the parameters for the **Wait for** command, select **Input#1** in the **Input Type** dropdown box and **High** in the **Value** dropdown box. The same values appear next to the command name in the program body on the left.

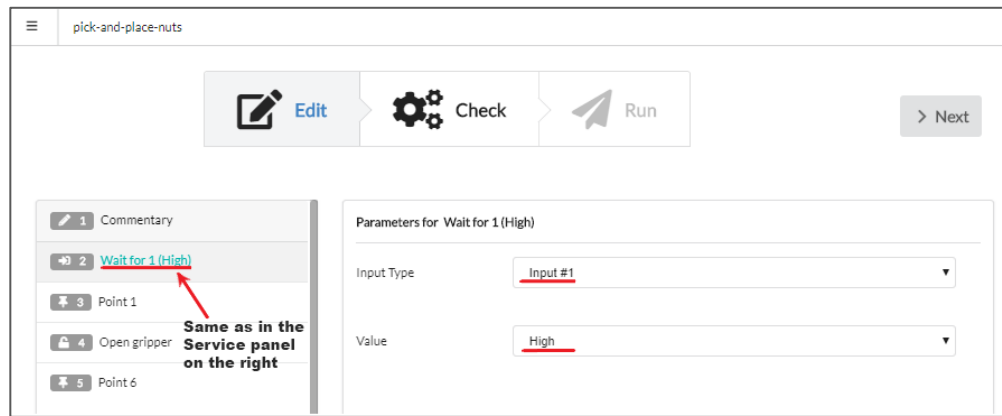

In this way, you let PULSE DESK know that it can move on to the subsequent commands once it receives the **High** signal from an external device (e.g., a button) connected to **Input#1** on the back panel of the control box.

31. In the program body, select **Point 9**, click **+**. In the displayed menu, select **Send to**. PULSE DESK adds the **Send to** command to the program body below **Point 9**.
32. In the fields of the **Service panel** for the **Send to** command, set the output that the arm should use to send a signal to external equipment—a conveyor belt, as well as the type of the signal. To do that, select **Output#1** in the **Output Type** dropdown box and **High** in the **Value** dropdown box.

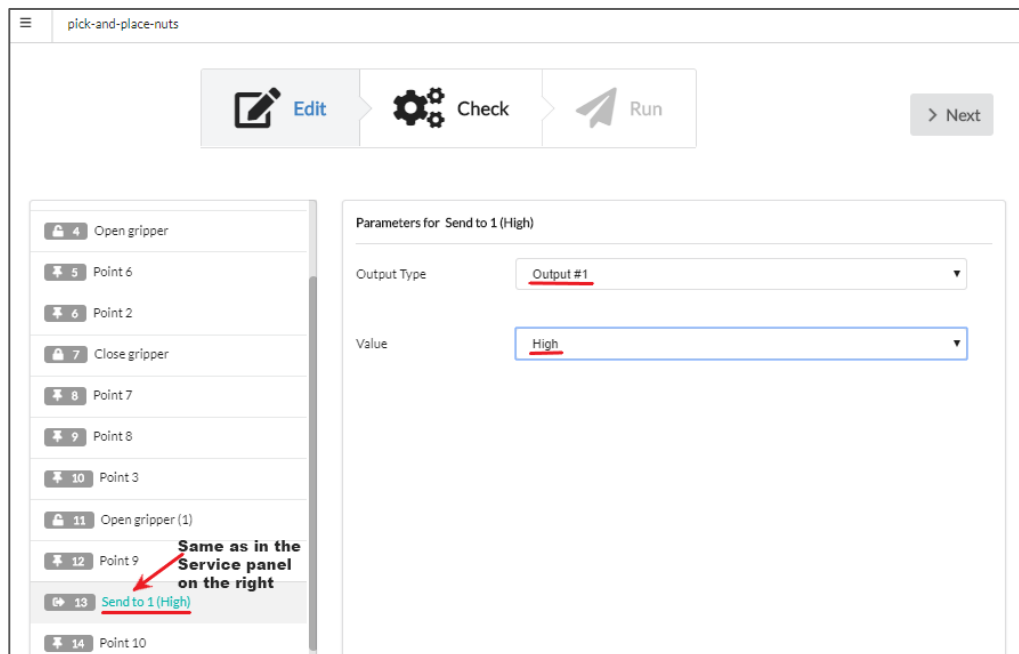

In this way, you set the conveyor belt connected to **Output#1** on the control box to switch on once it receives the **High** signal from the arm.

33. In the program body, select **Send to** and click , then select **Delay**. PULSE DESK adds the **Delay** command to the **Program Body** below **Send to**. The **Service panel** for the command contains only the **Time** field with the default value of 100 s.
34. In the **Time** field in the **Service panel**, change the default delay of 100 s to 5 seconds. The value indicates for how long the robotic arm should wait before moving on to execute another command.

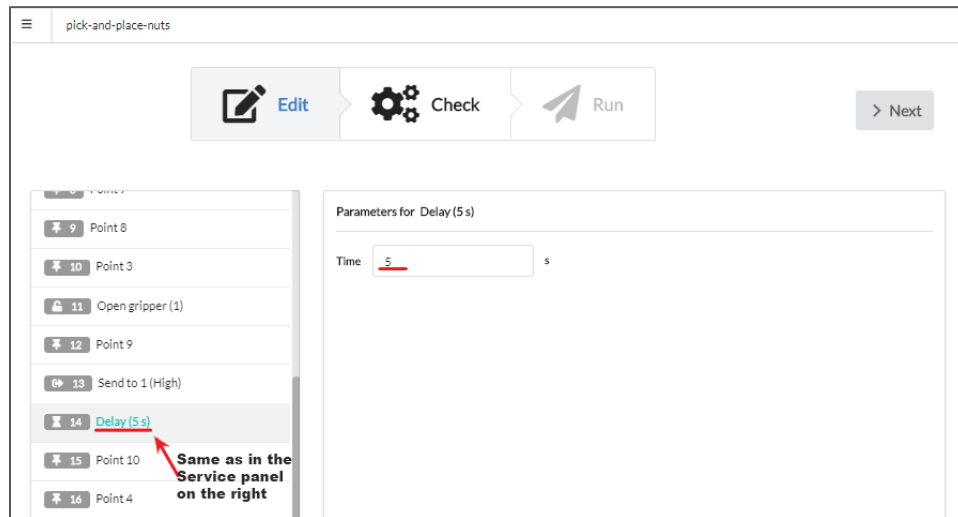

35. In the program body, select **Delay**, click . In the displayed menu, select **Send to**. PULSE DESK adds the **Send to (1)** command to the program body below **Delay**.
36. Set the parameters in the **Service panel** for the **Send to (1)** command as follows:
  - In the **Output Type** dropdown box, select **Output#1**.
  - In the **Value** dropdown box, choose **Low**.

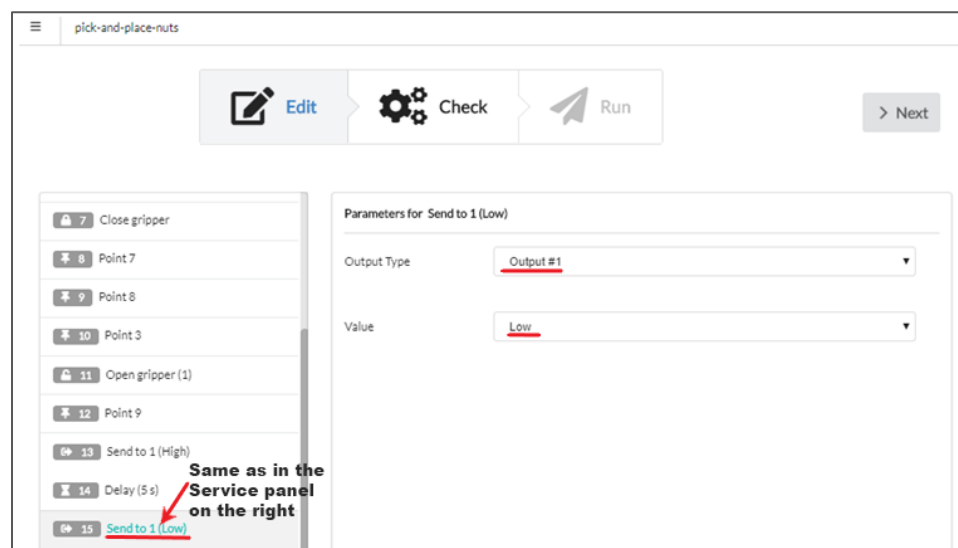



In this way, you set the conveyor belt connected to **Output#1** on the back panel of the control box to switch off once it receives the **Low** signal from the arm.

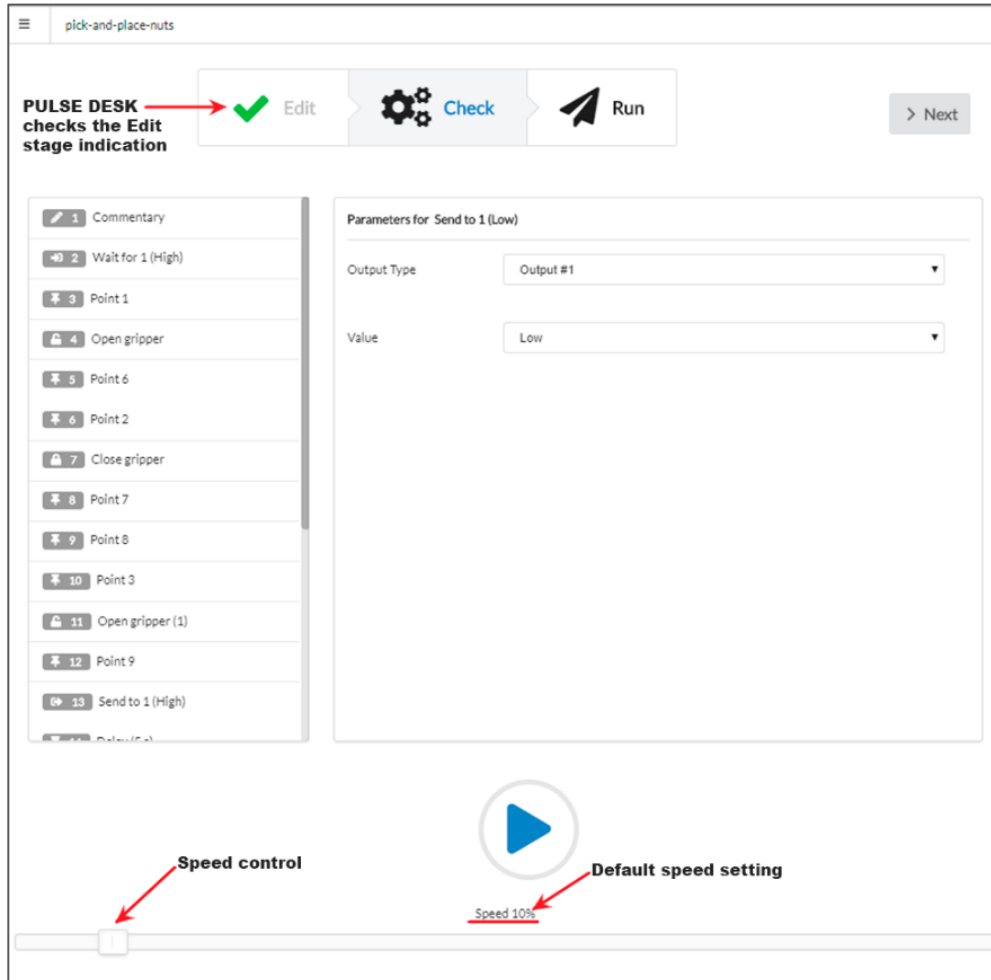

37. Click **Next** or **Check** in the **Stepper** to move on to check the created program. PULSE DESK switches to the **Check** stage screen as shown below.



### Conducting a test run

38. Adjust the speed control value to 20% by dragging the speed control to the right.
39. Click  PULSE DESK starts executing the specified sequence of commands from first command in the program body and down. The  button changes to . You can monitor the test run progress by the way PULSE DESK moves the selection from one command to another.



*When selection is at the Wait for, Send to, or Delay commands, PULSE DESK displays  next to . Click  to skip the commands.*



*In case, during a test run, you find out some of the preset parameters need adjustment, click  and switch to the Edit stage to make necessary adjustments.*

40. When PULSE DESK executes the last command, it stops and displays an appropriate warning. Click **OK** to return to the **Check stage screen**.

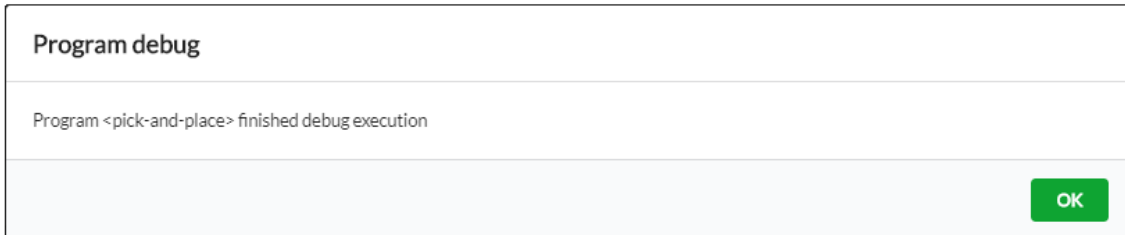

41. Click **Next** to move on to execute the program. If you click **Next**, PULSE DESK displays the **Run stage screen**.

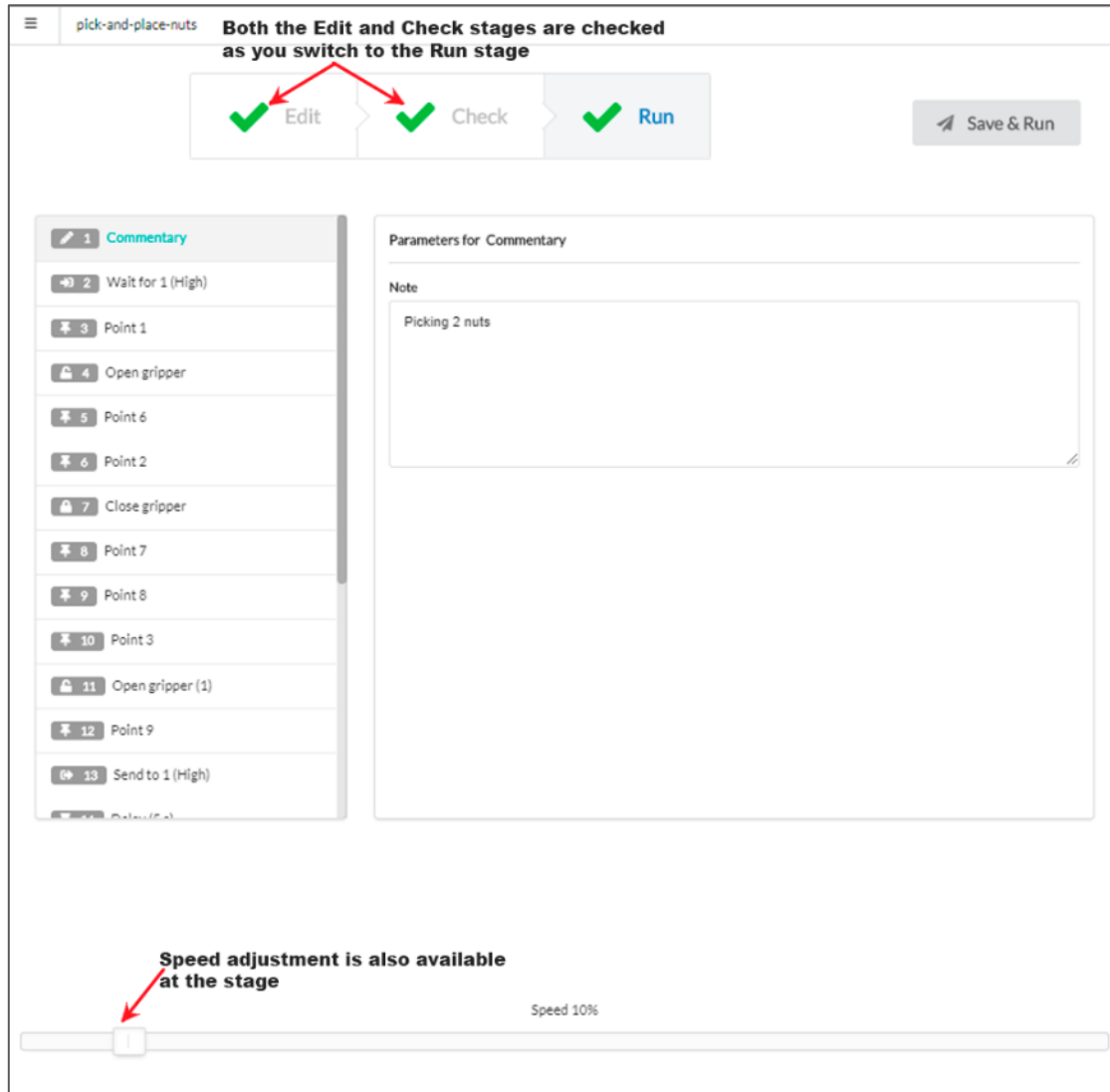

### Executing and stopping the program

42. On the Run stage screen, click **Save&Run** to start execution of the program. PULSE DESK executes the sequence of commands in the **Program Body**.



*Since this pick-and-place program starts with the Wait for command, the arm begins motion only after it receives a proper signal from an external device—i.e., after you press the button.*

43. Click  (replaces the **Save&Run** button) to stop the program execution.



*If you click the Save&Run button again after stopping the program, PULSE DESK starts executing the program from the very beginning.*

44. Close the browser window to quit PULSE DESK.



*If you close the browser without stopping the program, the robotic arm continues executing it.*

## ANNEX II. KINEMATICS OF THE PULSE ARM

The kinematics of the PULSE robotic arm is described with three parameters of Denavit-Hartenberg convention as illustrated in **Figure I-1** and **Table I-1**. These parameters include:

- **d**—distance from the origin to the common normal along the z axis of the previous joint
  - **i** *The common normal of two non-intersecting joint axes is a line perpendicular to both axes.*
- **a**—length of the common normal
- **alpha**—angle of rotation about the common normal, from the previous z axis to the new one

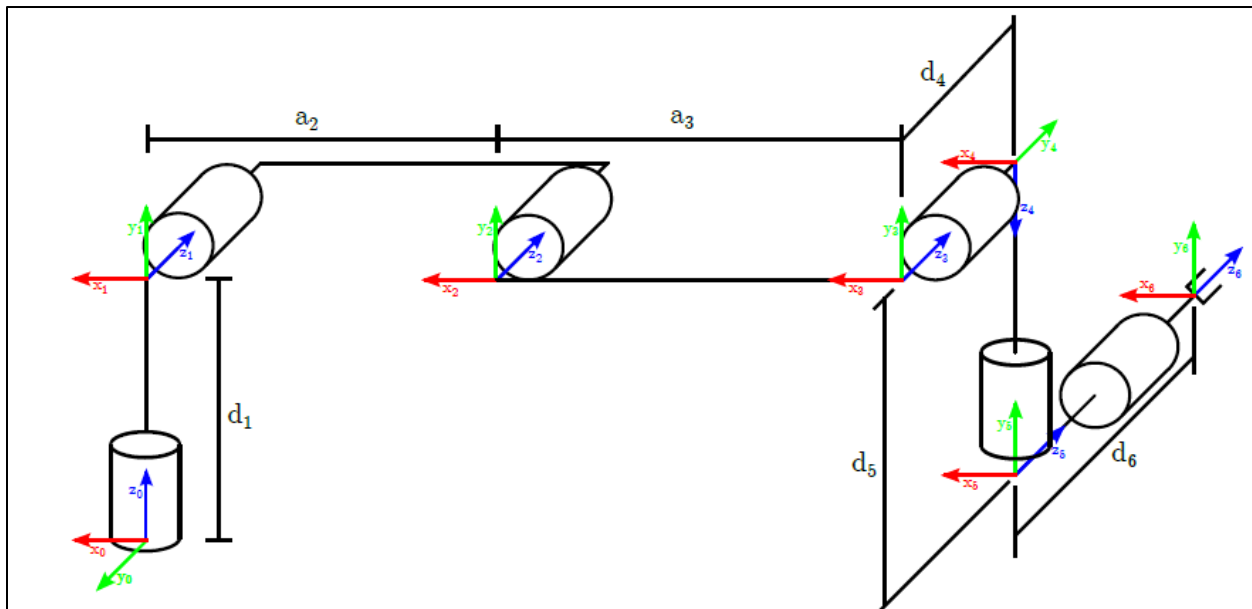

Figure I-1: Denavit-Hartenberg convention applied to PULSE robotic arms

**i** *The origin point is the intersection of Motor 1 and Motor 2 rotation axes.*

Table I-1: Denavit-Hartenberg parameters and their values

Joint	PULSE 75			PULSE 90		
	d(m)	a(m)	alpha(rad)	d(m)	a(m)	alpha(rad)
1	0.2325	0	$\pi/2$	0.2325	0	$\pi/2$
2	0	-0.375	0	0	-0.450	0
3	0	-0.295	0	0	-0.370	0
4	0.1205	0	$\pi/2$	0.1205	0	$\pi/2$

5	0.1711	0	$-\pi/2$	0.1711	0	$-\pi/2$
6	0.1226	0	0	0.1226	0	0



---

## ANNEX III. TROUBLESHOOTING

When the arm fails to execute a command, your **first step** is to check LEDs on the control box.

### I. WHEN THE RED LED IS ON:

1. Check that the emergency button is connected to the appropriate connector on the control box and make sure the button is unpressed. When needed, connect the button or unpress it.
2. Reboot the control box, paying attention to how the LEDs are lighting up.

**A. If the red LED lights up immediately** after you switch on power, go back to Clause 1.

**B. When the red LED lights up in about 1 minute** after power-on, this means that PC in the control box is actually loading and the problem is not related to the emergency button.

In this case, your **next step** is to contact the Technical Support Service.

To help detect and eliminate the problem as soon as possible, complete the actions as described in Clause 3 to 5 and report the results to the Technical Support Service.

3. Check if the PULSE DESK interface is loading. To do that, specify the following in the browser line: **http://<robot dynamic IP address>:8080** (for instructions on how to find out the dynamic IP address, see Section 3.2.2).
4. Send a GET/ POSE request via the arm API (for instructions on how to switch API access, see Section 6) and check the response. The response can be one of the following:

- **200 OK**

```
{
  "angles": [
    0,
    3.14159,
    1.57,
    -1.57,
    3.14,
    0
  ]
}
```

- **500 Internal Server Error**

"Robot unavailable in emergency state"

5. Get CAN logs and service logs. To do that, follow the instructions:

**Step 1:** Reboot the control box once again and wait until the red LED lights up.

**Step 2:** Get access to the CAN communication log by specifying the following in the browser line: **http://<robot dynamic IP address>:8080/logs/can**. Copy and save the log in a separate file and send it on to the Technical Support Service.

**Step 3:** Get access to service logs by specifying the following in the browser line: **http://<robot dynamic IP address>:8080/logs/service**. Copy and save the log in a separate file and send it on to the Help Desk.

## II. WHEN RED LED IS OFF AND THE GREEN LED IS ON:

Check if the response to your command contains the following error codes:

Error code	Cause	Details/ actions
400	Invalid JSON	Check and correct the syntax of the command.
412	Incorrect parameters	Make sure all mandatory parameters are specified and all parameter values are in accordance with API rules (see the <a href="#">API Reference Guide</a> ).
500	Server error/ collision/ unreachable position	When the problem is a server failure, contact the Technical Support Service.  When the problem is an unreachable position or a collision, try adding more waypoints to your motion trajectory.